



# Commercial Building Permit Application

CITY

## INFORMATION REQUIRED FOR OBTAINING A BUILDING PERMIT AS APPLICABLE

*Our goal is to review all plans within a two (2) week period from the time all required information has been submitted.*

<input type="checkbox"/> <b>A Building Permit Application</b>	<input type="checkbox"/> <b>A Site Plan (New &amp; Additions Only) Including:</b> <ul style="list-style-type: none"> <li>• Property lines and setbacks.</li> <li>• Easements.</li> <li>• Location of all buildings on the site.</li> <li>• Site drainage with existing and proposed contours shown at two (2) foot intervals. (NAVD 88 elevations)</li> <li>• Location and size of watermains/lines.</li> <li>• Location and size of sewer mains/lines.</li> <li>• Stormwater control features along with calculations.</li> <li>• Approaches.</li> <li>• The location of all access roads.</li> <li>• Location of all fire hydrants.</li> <li>• Public and private sidewalks.</li> <li>• Accessible route.</li> <li>• Parking spaces and sizes.</li> <li>• Building floor elevations.</li> <li>• Landscape plans.</li> <li>• Recycling space.</li> </ul>
<input type="checkbox"/> <b>All Civil Drawings To Be Submitted In Auto CADs Part Of The Plan Review – (Total of 2 Required)</b>	<input type="checkbox"/> <b>Plumbing Drawings Including:</b> <ul style="list-style-type: none"> <li>• State plan submittal/approval information.</li> <li>• Location and sizes of all water heaters.</li> <li>• Diagram showing water and waste piping locations and sizing.</li> <li>• Grease/oil separator or grease trap locations.</li> <li>• Location and sizes for water and sewer taps.</li> <li>• Types of material being used.</li> </ul>
<input type="checkbox"/> <b>Two (2) Complete Sets of Plans &amp; Specifications &amp; Other Relevant Documents Necessary to Evidence Code Compliance.</b> NOTE: All plans, and the title page of the specification book, shall bear the stamp of the appropriate licensed design professional. <b>All Plan Submittals Shall Include:</b> <ul style="list-style-type: none"> <li>• Full code review and calculations.</li> <li>• Floor plans showing all rooms, dimensions, names and/or uses for occupancy.</li> <li>• Wall and building sections showing floors, walls, and roof construction for all types.</li> <li>• Construction and location of all fire barriers, fire partitions, floor/ceiling and ceiling/roof assemblies, and their fire ratings along with appropriate listing numbers.</li> <li>• Fire details for penetrations – F &amp; T ratings.</li> <li>• Door and window schedules, which include fire ratings, hardware types and locations. Any tempered or fire-rated glazing to be identified on plans.</li> <li>• Emergency lighting, both interior and exterior.</li> <li>• Exit lighting and signs.</li> </ul>	<input type="checkbox"/> <b>Details Of Any Unique Items/Unique Construction</b>
<input type="checkbox"/> <b>Mechanical Drawings Including:</b> <ul style="list-style-type: none"> <li>• Documentation of MN Energy Code Compliance.</li> <li>• Location of combustion air, return air &amp; supply opening.</li> <li>• Furnace/boiler locations along with venting, BTU input/output ratings.</li> <li>• Smoke/Fire damper locations and installation details.</li> <li>• Flame spread ratings of all insulated ducts.</li> <li>• Gas piping sizes and locations and support.</li> <li>• Class I hoods and ducts and associated fire protection systems.</li> <li>• Shaft construction sections and appropriate system shut offs locations.</li> </ul>	<input type="checkbox"/> <b>Other Information As Deemed Necessary By The Building Official.</b>
<input type="checkbox"/> <b>Construction Stormwater Permit Application (Required for Category 2 and Category 3 Land Disturbing Activity)</b>  <p style="text-align: center;"><i>No structure shall be used, occupied, or furnished until a Certificate of Occupancy has been issued by the Building Department.</i></p>	



## COMMERCIAL/RESIDENTIAL BUILDING PERMIT APPLICATION

<b>Address of Building Site:</b>	<b>Parcel Number:</b>
----------------------------------	-----------------------

Legal Description:	
Type of Improvement: <input type="checkbox"/> New <input type="checkbox"/> Alteration <input type="checkbox"/> Addition <input type="checkbox"/> Repair <input type="checkbox"/> Reroof <input type="checkbox"/> Raze <input type="checkbox"/> Move	
Project Description:	<b>Estimated Cost:</b>
Applicant is: <input type="checkbox"/> Owner <input type="checkbox"/> Licensed Contractor <input type="checkbox"/> Architect/Engineer <input type="checkbox"/> Project Manager <input type="checkbox"/> Other	

<b>Property Owner Name:</b>			
<b>Street Address:</b>	<b>City:</b>	<b>State:</b>	<b>Zip:</b>
<b>Contact Person:</b>	<b>Telephone Number:</b>	<b>Email:</b>	

<b>Applicant Name:</b>		<b>License Number:</b>	
<b>Street Address:</b>	<b>City:</b>	<b>State:</b>	<b>Zip:</b>
<b>Contact Person:</b>	<b>Telephone Number:</b>	<b>Email:</b>	

<b>Contractor Name:</b>		<b>License Number:</b>	
<b>Street Address:</b>	<b>City:</b>	<b>State:</b>	<b>Zip:</b>
<b>Contact Person:</b>	<b>Telephone Number:</b>	<b>Email:</b>	

<b>Designer Name:</b>		<b>License Number:</b>	
<b>Street Address:</b>	<b>City:</b>	<b>State:</b>	<b>Zip:</b>
<b>Contact Person:</b>	<b>Telephone Number:</b>		

<b>Excavator Name:</b>			
<b>Street Address:</b>	<b>City:</b>	<b>State:</b>	<b>Zip:</b>
<b>Contact Person:</b>	<b>Telephone Number:</b>		

<b>Mechanical Contractor Name:</b>			
<b>Street Address:</b>	<b>City:</b>	<b>State:</b>	<b>Zip:</b>
<b>Contact Person:</b>	<b>Telephone Number:</b>		

<b>Plumbing Contractor Name:</b>			
<b>Street Address:</b>	<b>City:</b>	<b>State:</b>	<b>Zip:</b>
<b>Contact Person:</b>	<b>Telephone Number:</b>		

**Signature of Applicant or Agent:** \_\_\_\_\_ **Date:** \_\_\_\_\_



# ALEXANDRIA FIRE DEPARTMENT

302 FILLMORE STREET

ALEXANDRIA, MN 56308

Phone: 320-763-6489 Fax: 320-762-9723



- Commercial                       Industrial                       Institutional
- Multi-Family                       Public Facility

## FIRE SUPPRESSION/DETECTION SYSTEM PERMIT APPLICATION

Date: \_\_\_\_\_ Permit Number: \_\_\_\_\_

Building Address \_\_\_\_\_

Owner's Name \_\_\_\_\_

Address \_\_\_\_\_

Phone # \_\_\_\_\_

Contractor's Name: \_\_\_\_\_

Address \_\_\_\_\_

Phone # \_\_\_\_\_ State License # \_\_\_\_\_

\*\*\*\*\*

Type of Work (check one):     New     Addition     Repair     Alteration

### System Valuation

Total Fire Suppression/Protection System Contract Amount: \_\_\_\_\_

Permit Fee: \$50

Payable to: City of Alexandria  
302 Fillmore St  
Alexandria, MN 56308

**A Set of approved plans by the MN State Fire Marshal and SFM documentation approval are required.**

This permit does not relieve the contractor from compliance with appropriate Federal, State or Local regulations concerning this installation. The contractor certifies that the above information is correct.

Applicant Signature: \_\_\_\_\_

Fire Chief Signature: \_\_\_\_\_



**City of Alexandria**  
**Commercial Project - Final HVAC & ELECTRICAL Systems**  
**Equipment Commissioning Report**

Pursuant to 2015 Minnesota Energy Code, MN Rule Chapter 1323 Commercial Energy Code, Section C408, a final HVAC and ELECTRICAL Systems Commissioning/Testing Report is required for this building project.

Under this provision, the Minnesota Energy Code (and your specified commissioning plan) requires that HVAC and Electrical System installations installed as part of this building project be final tested and adjusted for proper function and performance to ensure that control elements are balanced and calibrated and in proper working condition, and that components, equipment, systems, and interfaces between systems conform to the construction documents/design as required by the Energy Code.

This project's Energy Code design requires that HVAC and ELECTRICAL System Commissioning be completed and that appropriate documentation be submitted to the CCLD Building Official as evidence of Energy Code compliance. For required reporting purposes, this form shall be used to certify that required HVAC and Electrical Systems have been properly commissioned in accordance with your plan and with the specific provisions of the Minnesota Commercial Energy Code, Rule Chapter 1323, Section C408, as outlined herein.

**City of Alexandria's Permit Number:** \_\_\_\_\_

Project Name: \_\_\_\_\_

Project Site Address: \_\_\_\_\_

Project Architect: \_\_\_\_\_

Project Mechanical Engineer: \_\_\_\_\_

Project Electrical Engineer: \_\_\_\_\_

***I hereby certify that required HVAC and Electrical Commissioning is now complete; that required testing procedures and protocol have been followed; that all discrepancies have been corrected; and that the required HVAC and Electrical Commissioning process has been accomplished as mandated by the 2015 Minnesota State Building Code, MN Rule Chapter 1323 Commercial Energy Code, Section C408.***

Project Commissioning Agent (Alt.)	Date	Project Architect	Date
------------------------------------	------	-------------------	------

Project Electrical Engineer	Date	Project Mechanical Engineer	Date
-----------------------------	------	-----------------------------	------

Minnesota Department of Labor and Industry  
 Construction Codes and Licensing Division  
 Building Plan Review/Inspections  
 443 Lafayette Road North  
 St. Paul, MN 55155-4341  
 Phone: (651) 284-5068 Fax: (651) 284-5749  
 www.dli.mn.gov



MINNESOTA DEPARTMENT OF  
**LABOR & INDUSTRY**

Reset

## Special Structural Testing and Inspection Program Summary Schedule

PRINT IN INK or TYPE your responses.

PROJECT NAME	PROJECT NO.
LOCATION	PERMIT NO.

Technical (2)		Description (3)	Type of Inspector (4)	Specific Report Frequency (5)	Assigned Firm (6)
Section	Article				

Note: **This schedule shall be filled out and included in a Special Structural Testing and Inspection Program.**  
 (If not otherwise specified, assumed program will be "Guidelines for Special Inspection & Testing" as contained in the State Building Code and as modified by the state adopted IBC.)  
 \*A complete specification-ready program can be downloaded directly by visiting CASE/MN at [www.cecm.org](http://www.cecm.org)\*

- (1) Permit No. to be provided by the Building Official
- (2) Referenced to the specific technical scope section in the program.
- (3) Use descriptions per IBC Chapter 17, as adopted by Minnesota State Building Code.
- (4) Special Inspector – Technical (SIT); Special Inspector – Structural (SIS)
- (5) Weekly, monthly, per test/inspection, per floor, etc.
- (6) Name of Firm contracted to perform services.

**ACKNOWLEDGEMENTS**  
 (Each appropriate representative shall sign below)

Owner: _____	Firm: _____	Date: _____
Contractor: _____	Firm: _____	Date: _____
Architect: _____	Firm: _____	Date: _____
SER: _____	Firm: _____	Date: _____
SI-T _____	Firm: _____	Date: _____
SI-S: _____	Firm: _____	Date: _____
TA: _____	Firm: _____	Date: _____
F: _____	Firm: _____	Date: _____

If requested by engineer/architect of record or building official, the individual names of all prospective special inspectors and the work they intend to observe shall be identified as an attachment.

Legend: SER = Structural Engineer of Record    SI-T = Special Inspector - Technical    TA = Testing Agency  
 SI-S = Special Inspector - Structural    F = Fabricator

Accepted for the Building Department By \_\_\_\_\_ Date \_\_\_\_\_

This material can be made available in different forms, such as large print, Braille or on a tape. To request, call 1-800-342-5354 (DIAL-DLI) Voice or TDD (651) 297-4198.

**Category 1 and Category 2 Land Disturbing activity shall comply with the Minnesota Pollution Control Agency's Best Management Practices (BMPs).**

*The purpose of requiring this information as a part of the building permit application process is to minimize both short-term and long-term erosion, contain sediment on site and manage post construction runoff.*

**The Following Land Disturbing Activities Require an Erosion and Sediment Control Plan Sketch.**

- Category 1** - Construction activities disturbing less than ½ acre that include new construction, demolition, remodel/addition, accessory structure and/or landscaping/retaining walls.

**The Following Land Disturbing Activities Require a Stormwater Management Plan.**

- Category 2** – Construction disturbing equal to or greater than ½ acre, but less than 1 acre; or construction on riparian lake lots (except attached decks and 2015 Minnesota Building Code, Section 1300.0120, Subp. 4. Work Exempt from Permit); or construction that is determined by the City Engineer to present a substantial risk to neighboring private properties, public infrastructure or waterways/wetlands.
- Category 3** – Construction activities disturbing equal to or greater than 1 acre. (Also requires separate MPCS Construction Stormwater Permit)

**Category 1 Plan Requirements:**

- **The Following Must be Included in or Attached to the Plan Sketch**
  - Location and type of perimeter erosion control
  - Proposed construction exit location and material that it will be constructed of
  - Location and type of other erosion prevention and sediment control BMPs
  - Location and type of inlet protection for all storm sewer inlets downstream of the site within one block or as directed by City Engineer
  - Name, telephone number and email address of individual responsible for the site and maintenance of the erosion and sediment controls
  - Standard illustrations (details) of proper installation of erosion prevention and sediment control BMPs (MnDOT details provided for reference, pages 9-17)
- **The Following Notes Must be Placed on Plan Sketch and Adhered to as Applicable:**
  - The street shall be swept clean before the end of each day of active construction, when sediment is tracked onto the street.
  - Areas with slopes greater than 3:1 and areas adjacent to wetlands/waterbodies disturbed during construction shall be protected with temporary vegetation, mulching or other means as soon as practical.
  - All exposed soil areas shall be stabilized as soon as practical.
  - Unworked soils that remain exposed and not in use for longer than 14-days shall be seeded with temporary seed (grass, oats or wheat) in addition to being stabilized.
  - No concrete washout shall occur on site unless it is done with an approved MPCA device or standard.
  - Stockpiles shall be stabilized and surrounded with adequate perimeter control to prevent sedimentation.
  - Inlet protection for all storm sewer inlets downstream and within one block of the site shall be installed and maintained.
  - Site shall be kept clean at all times and refuse properly controlled.
  - Temporary pumping shall not be permitted without use of an approved MPCA device or standard.
  - Soil compaction shall be minimized.
  - All temporary synthetic BMPs to be removed upon permanent stabilization.

## Category 1 Erosion and Sediment Control Plan Sketch

(This page is **not** required for Category 2 or Category 3)

Please Show:

- Location and type of perimeter control
- Location and type of construction exit
- Location and type of other erosion prevention and sediment control BMPs
- Location and type of inlet protection for all storm sewer inlets within 1 block downstream
- Name, telephone number and email address of individual responsible for the site and maintenance of the erosion and sediment controls.
- Standard illustrations (details) of proper installation of erosion prevention and sediment control BMPs

- The street shall be swept clean before the end of each day of active construction, when sediment is tracked onto the street.
- Areas with slopes greater than 3:1 and areas adjacent to wetlands/waterbodies disturbed during construction shall be protected with temporary vegetation, mulching or other means as soon as practical.
- All exposed soil areas shall be stabilized as soon as practical.
- Unworked soils that remain exposed and not in use for longer than 14-days shall be seeded with temporary seed (grass, oats or wheat) in addition to being stabilized.
- No concrete washout shall occur on site unless it is done with an approved MPCA device or standard.
- Stockpiles shall be stabilized and surrounded with adequate perimeter control to prevent sedimentation.
- Inlet protection for all storm sewer inlets downstream and within one block of the site shall be installed and maintained.
- Site shall be kept clean at all times and refuse properly controlled.
- Temporary pumping shall not be permitted without use of an approved MPCA device or standard.
- Soil compaction shall be minimized.
- All temporary synthetic BMPs to be removed upon permanent stabilization.



**Category 2 Plan Requirements:**

- Two sets of clearly legible copies of permit submittals and required information shall be submitted to the City and shall be accompanied by all appropriate fees.
- Drawings prepared at a minimum scale of 1 inch equals 50 feet.
- Project name and date of preparation.
- Names, addresses and phone numbers of the land surveyor, and engineer, if any.
- Project description including property boundaries, areas to be disturbed, and the nature and purpose of the land disturbing activity and the amount of grading involved.
- Spot elevations of proposed grades in relation to existing grades on the subject property and adjacent properties.
- Existing site conditions including topography, vegetation and drainage arrows.
- Areas where finished slope will be steeper than 5:1.
- Critical erosion areas including areas on the site that have potential for erosion problems.
- Erosion and sediment control devices including methods to be used to control erosion on the site, both during and after the construction process.
- Location of storm drains, wetlands, sediment ponds and lakes.
- Location of material stockpiles.
- Plan for temporary site stabilization.
- Permanent stabilization including how the site will be stabilized after construction is completed, including specifications.
- Temporary rock exit location.
- Name of individual responsible for installation and maintenance of control devices, including a schedule of regular inspections and repair of erosion and sediment control structures.
- Adjacent areas including neighboring streams, roads, residential areas, etc. which might be affected by the land disturbing activity.
- Project schedule including a projected timeframe for completion of all site activities.
- Phasing of construction including the nature and purpose of the land disturbing activity, utilities, and building construction.
- Provisions for the removal of temporary synthetic erosion prevention and sediment control BMPs upon establishment of permanent vegetation.
- Standard illustrations (details) of proper installation of erosion prevention and sediment control BMPs (MnDOT details provided for reference, pages 11-19).

**Category 3 Plan Requirements:**

All projects disturbing equal to or greater than **1 acre** must obtain a permit from the MPCA to discharge stormwater associated with construction activity. This permit requires preparation of a SWPPP which details erosion control practices, sediment control practices, dewatering and basin draining, inspection and maintenance, final stabilization and permanent stormwater management.

A pre-construction meeting, preferably at the construction site, including the operator/general contractor, the site grading contractor, the City of Alexandria Stormwater Inspector, and (if feasible) the owner or owner's representative and the individual preparing the SWPPP shall take place prior to start of construction.

***Please submit all the above information at the time of CSP application.***

**CITY OF ALEXANDRIA  
Building Department 704 Broadway  
Alexandria, MN 56308**

**(320) 763-6678 – Phone / (320) 763-3511 – Fax**



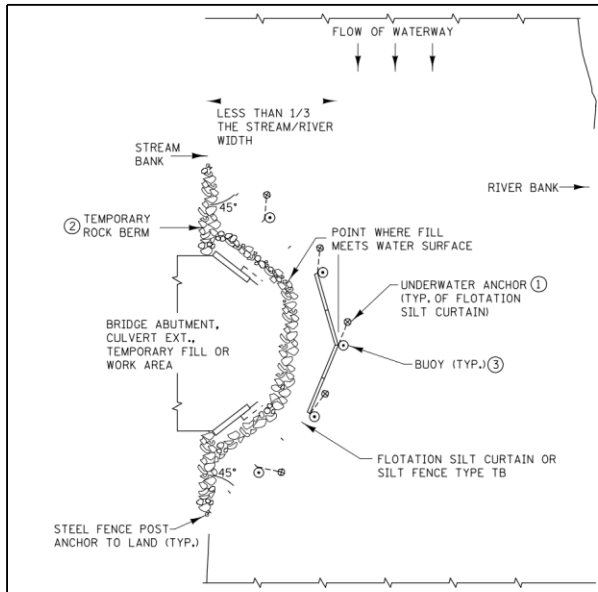

PLAN VIEW FOR STREAM @

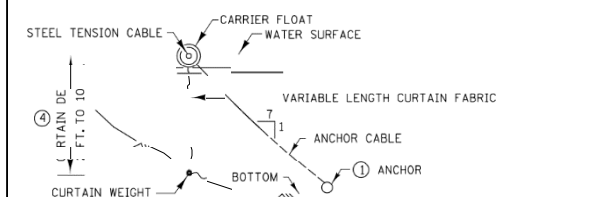

FLOTATION SILT CURTAIN

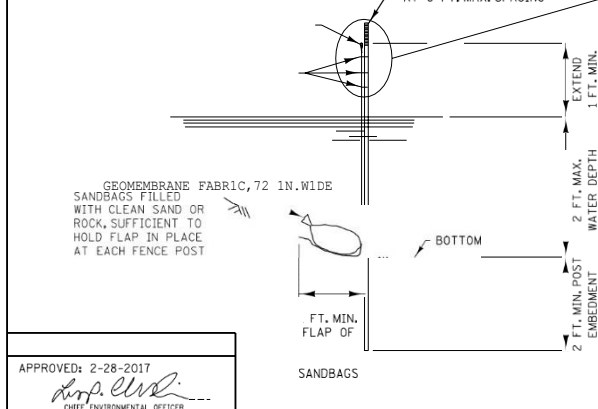

APPROVED: 2-28-2017  
 Chief Environmental Officer

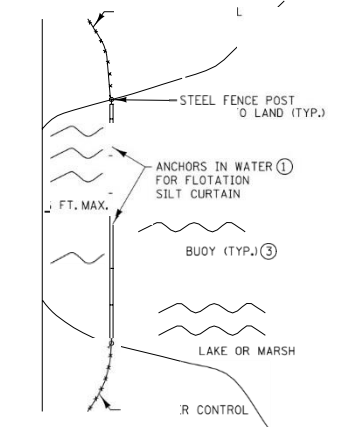

PLAN VIEW FOR LAKE OR MARSHY

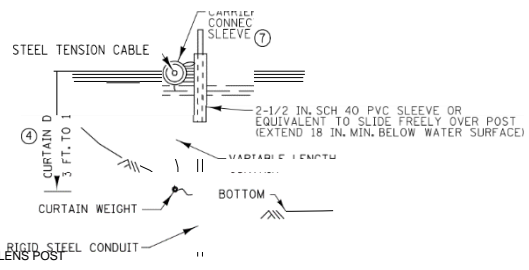

ALTERNATE FLOTATION SILT CURTAIN

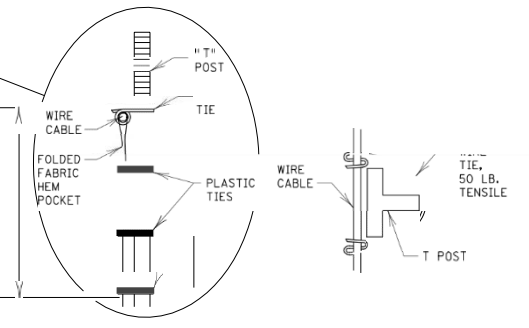

FABRIC/CABLE/POST CONNECTION

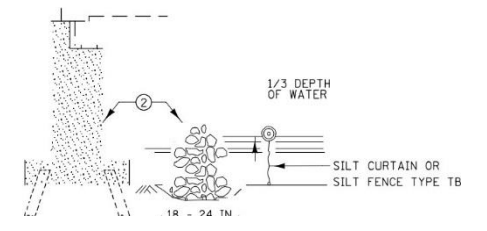

TEMPORARY ROCK BERM

INSTALLATION GUIDELINES  
 SILT FENCE TYPE TB

INSTALLATION GUIDELINES  
 FLOTATION SILT CURTAIN  
 TYPE: STILL WATER  
 MAXIMUM WATER VELOCITY: 2 FT./SEC.

INSTALLATION GUIDELINES  
 FLOTATION SILT CURTAIN  
 TYPE: MOVING WATER  
 MAXIMUM WATER VELOCITY: 5 FT./SEC.  
 MAXIMUM WAVE HEIGHT: 2 FT.

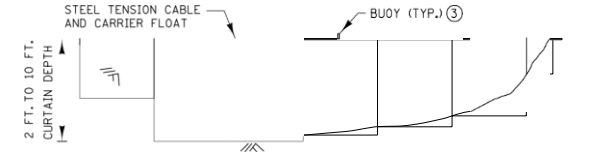

FRONT VIEW FOR FLOTATION SILT CURTAIN

NOTES:

- SEE SPCCS 2573, 3886, 3887 & 3893.
  - IN AREAS WHERE THE PLAN CALLS FOR RIPRAP AT A BRIDGE, CULVERT, OR SLOPE, A TEMPORARY RIPRAP ANCHOR SPACING AND WEIGHT REQUIREMENTS. SEE SPEC. 2573.
  - WHEN THE WORK IS COMPLETE THE RIPRAP CAN THEN BE MOVED TO THE PERMANENT LOCATION INDICATED IN THE PLANS. THE TEMPORARY ROCK BERM IS INCIDENTAL.
  - ON U.S. COAST GUARD OR OTHER MOTORIZED WATERWAYS, BUOYS ARE REQUIRED TO MARK THE ENDS AND SPECIAL AREAS FOR VISIBILITY. PLACE BUOYS AS REQUIRED FOR NAVIGATIONAL PURPOSES.
  - MINIMUM WATER DEPTH APPLIES TO THE DEEPEST POINT ALONG THE FLOTATION SILT CURTAIN OR SILT FENCE TYPE TB FOR DETERMINING APPLICABILITY OF FLOTATION SILT CURTAIN OR SILT FENCE TYPE TB.
  - SILT CURTAIN SHOULD BE REMOVED WHEN THE AREA CONTRIBUTING DIRECT RUNOFF HAS BEEN TEMPORARILY OR PERMANENTLY STABILIZED. SILT CURTAIN SHOULD ALSO BE REMOVED BEFORE WINTER IF ICE UP OR ICE FLOW IS ANTICIPATED.
- BUT IN NO CASE SHALL EMBEDMENT BE LESS THAN 2 FEET.  
 EMBED POST INTO BOTTOM A MINIMUM OF 40% OF THE WATER DEPTH (INCLUDING WAVE HEIGHT)
- ANCHOR FLOAT MUST BE CONNECTED SECURELY TO SLEEVE WITH A MINIMUM TENSILE STRENGTH OF 100 LBS. CONNECTION METHOD MUST ALLOW FOR SLEEVE TO MOVE FREELY ON POST.
- PROVIDE SUFFICIENT NUMBER OF POST ANCHORS TO MAINTAIN SILT CURTAIN POSITION.

APPROVED: [Signature]  
 STATE DESIGN ENGINEER

TEMPORARY SEDIMENT CONTROL

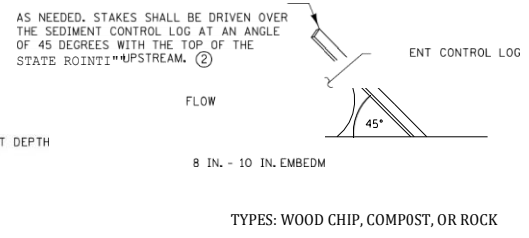
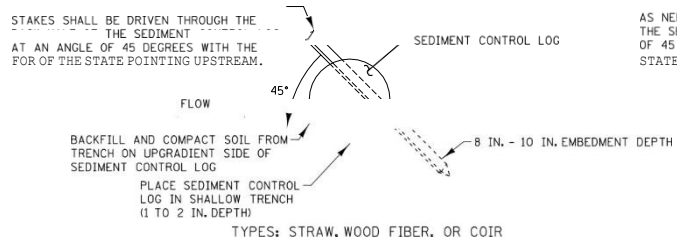

### SEDIMENT CONTROL LOGS

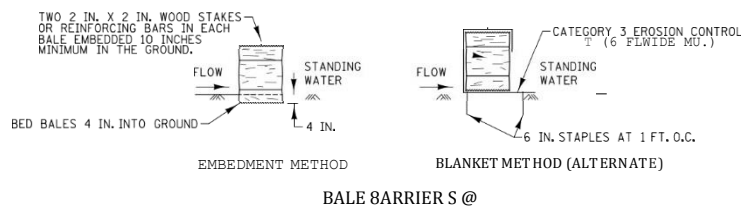
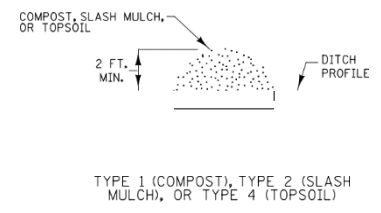
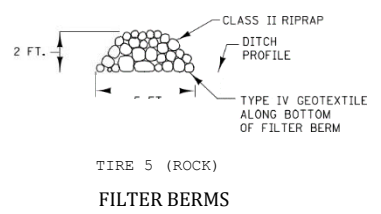
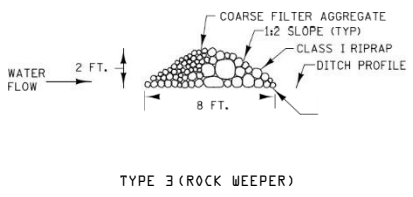

**NOTES:**

SEE SPECS. 2573, 314 9.5874, 3882, 3886, & 5897.

SRAOF BETWEEN STATES SHALL BE A MAXIMUM OF 1 FOOT FOR DITCH CHECKS OR 2 FEET FOR PLACEMENTS AS NEEDED TO PREVENT MOVEMENT OF SEDIMENT CONTROL LOGS PLACED ON

③ TO BE USED FOR CRITICAL PERIMETER CONTROL AREAS WHERE STANDING WATER OCCURS (6 INCH MAX. DEPTH). BALES SHALL CONSIST OF TYPE 1 MULCH OF APPROXIMATELY 14 IN. X 18 IN. X 36 IN. LONG. BALES SHALL BE PLACED ON EDGE AND BUTTED TIGHT TO ADJACENT BALES.

INSTEAD OF TRENCHING, PLACE BALE ON THE BLANKET AND \*RAP BLANKET AROUND THE BALE PLACE STAKE THROUGH BALE AND BLANKET.

APPROVED: 2-28-2017  
  
 CHIEF ENVIRONMENTAL OFFICER

DEPARTMENT OF TRANSPORTATION  
 STATE DESIGN ENGINEER  
 APPROVED: 2-28-2017

TEMPORARY SEDIMENT CONTROL  
 STANDARD PLAN 5-29T.405  
 2 OF 8

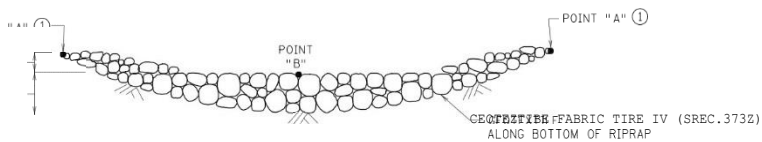

**ROCK DITCH CHECKS**  
**F 7LTER BERMS TYPE 3 (ROCK WEEP ER) OR FILTER TYPE 5 (RO CK) @ @**  
 (FOR USE ON ROUGH GRADED AREAS)

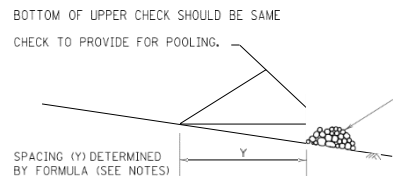

**DITCH CHECK SPACING**  
 (FOR ALL FILTER BERM TYPES)

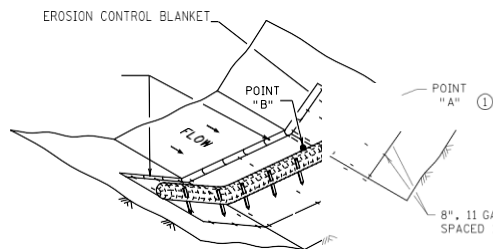

EROSION CONTROL BLANKET ANCHOR TRENCH. BACKFILL WITH TAMPED NATURAL SOIL.

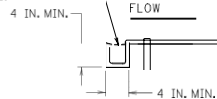

8", 11 GA. STAPLES SPACED 1' 0" ON CENTER

1 IN. X 2 IN. X 24 IN. LONG WOODEN STAKES AT 1 FT. MAXIMUM SPACING. STAKES SHALL BE DRIVEN THROUGH THE BACK HALF OF THE SEDIMENT CONTROL LOG AT AN ANGLE OF 45 DEGREES WITH THE TOP OF THE STAKE POINTING UPSTREAM.

SEDIMENT CONTROL LOG TYPE WOOD FIBER  
 EROSION CONTROL BLANKET CATEGORY 3 (8 FT. MIN. WIDTH)



STAPLE BLANKET IN ROWS WITH 6 IN. STAPLES AT 18 IN. MAX. SPACING WITHIN ROWS AND 2 FT. MAX. SPACING BETWEEN ROWS. LEADING AND TRAILING EDGE SHALL BE STAPLED APPROX. 6 IN. FROM EDGE (TYP.)

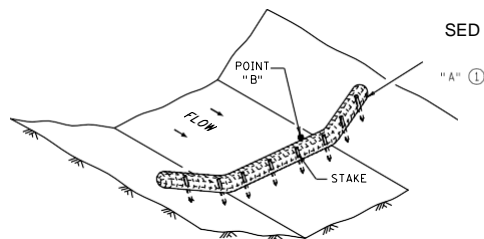

**SEDIMENT CONTROL LOG TYPE WOOD FIBER OR TYPE COMPOSTS**

FOR DITCH CHECKS, PLACE SEDIMENT CONTROL LOG PERPENDICULAR TO FLOW AND IN A CRESCENT SHAPE WITH THE END FACING UPSTREAM.  
 APPROXIMATE SPACING BETWEEN EACH DITCH CHECK SHOULD BE DETERMINED FROM THE FOLLOWING SPACING FORMULA:

- ① POINT "A" MUST BE A MINIMUM OF 6 INCHES HIGHER THAN POINT "B" TO ENSURE THAT WATER FLOWS OVER THE
- ② PERMANENT ROCK DITCH CHECKS PLACED WITHIN THE CLEAR ZONE ARE TO BE 18" OR LESS IN HEIGHT. A 1:6 APPROACH AND DEPARTURE SLOPE SHALL BE PROVIDED.
- ④ DITCH GRADE 1.5% - 3%, MAX. FLOW VELOCITY 4.5 FT./SEC..
- ⑤ DITCH GRADE 1.5% - 3%, MAX. FLOW VELOCITY 1.5 FT./SEC..

REVISION: \_\_\_\_\_  
 APPROVED: 2-28-2011  
*[Signature]*  
 CHIEF ENVIRONMENTAL OFFICER

**mn**  
 MINNESOTA  
 DEPARTMENT OF TRANSPORTATION  
*[Signature]*  
 STATE DESIGN ENGINEER

TEMPORARY SEDIMENT CONTROL

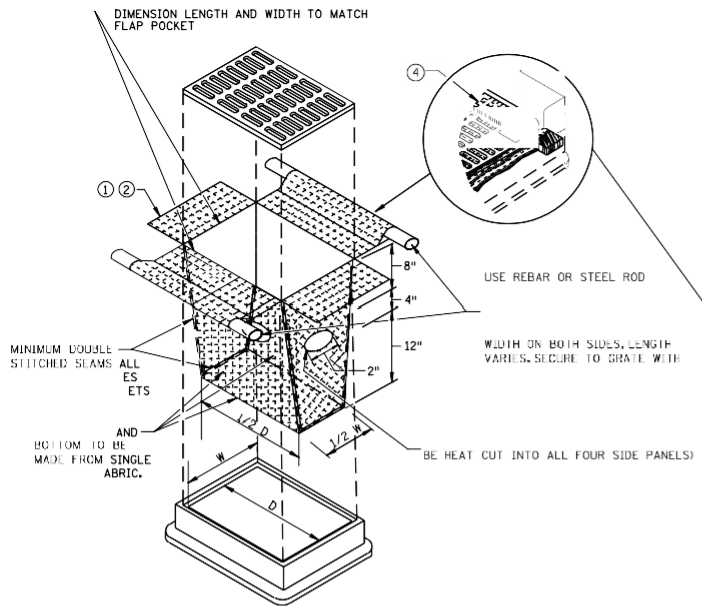

FILTER BAG INSERT @

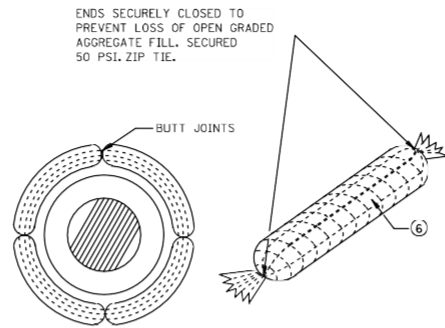

ROCK LOG/COMPOST LOG

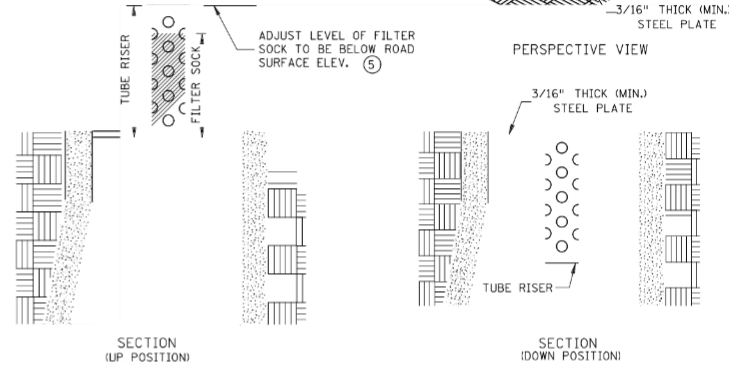
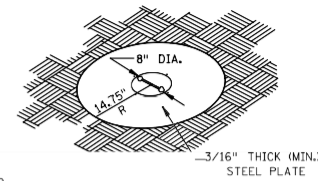
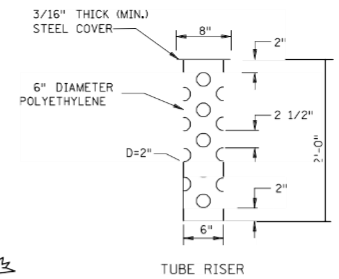

POP-UP HEAD

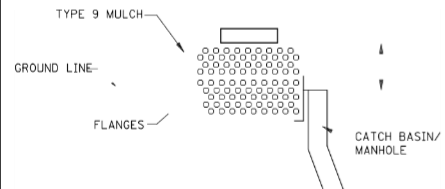

SEDIMENT CONTROL INLET HAT

NOTE: THE SEDIMENT CONTROL BARRIER SHALL BE A METAL OR PLASTIC/POLYETHYLENE RISER SIZED TO FIT INSIDE THE CATCH BASIN/MANHOLE; HAVE PERFORATIONS TO ALLOW FOR WATER INFILTRATION; HAVE AN OVERFLOW OPENING, FLANGES AND A LID/COVER.

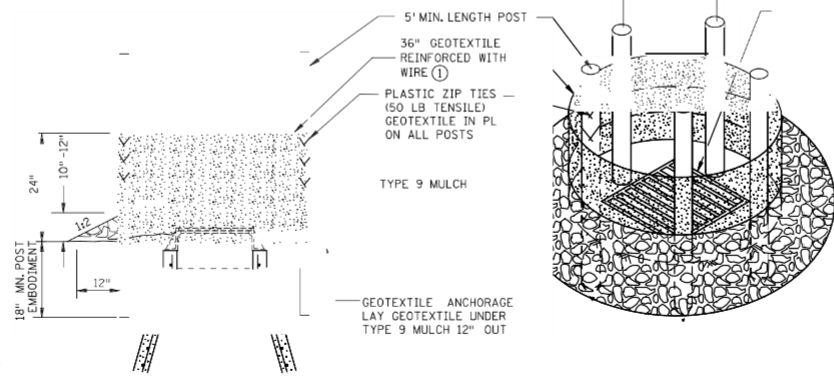

SILT FENCE RING AND ROCK FILTER BERM

USE WHERE INLET DRAINS IN AN AREA WITH SLOPES AT 1:3 OR LESS

- NOTES:
- DEVICES MUST BE ADJUSTED ACCORDINGLY AS TO NOT CAUSE FLOODING ON ROADWAY
  - ① ALL GEOTEXTILE USED FOR INLET PROTECTION SHALL BE MONOFILAMENT IN BOTH DIRECTIONS, MEETING SPEC. 3BB6.
  - ② FINISHED SIZE, INCLUDING POCKETS HERE REQUIRED SHALL EXTEND A MINIMUM OF 10 INCHES AROUND THE PERIMETER TO FACILITATE MAINTENANCE OR REMOVAL.
  - DO NOT PLACE FILTER BAG INSERT IN INLETS SHALLOWER THAN 30 INCHES. PLACED BAG SHALL HAVE A MINIMUM SIDE CLEARANCE OF 3 INCHES BETWEEN TO ACHIEVE THE 3 INCH SIDE CLEARANCE.
  - ④ FLAP POCKETS SHALL BE LARGE ENOUGH TO ACCEPT WOOD 2 INCH X 4 INCH OR USE A ROCK SOCK OR SAND BAGS IN PLACE OF THE FLAP POCKETS.
  - ⑤ SOCK HEIGHT MUST NOT BE SO HIGH AS TO SLOW DOWN WATER FILTRATION TO CAUSE
- GEOTEXTILE SOCK BETWEEN 4-10 FEET LOGO AND 4-6 INCH DIAMETER. SEAM TO BE JOINED BY TWO ROWS OF STITCHING WITH A PLASTIC MESH BACKING OR PROVIDE A
- COARSE AGGREGATE
- CONFORMING TO SPEC. 5157 TABLE 5157-1; CA-3 GRADATION.

APPROVED: 2-28-2017  
  
 CHIEF ENVIRONMENTAL OFFICER

DEPARTMENT OF TRANSPORTATION  
 STATE DESIGN ENGINEER

APPROVED: 2-28-2017

TEMPORARY SEDIMENT CONTROL  
 STANDARD PLAN 5-29T.405 4 OF 8

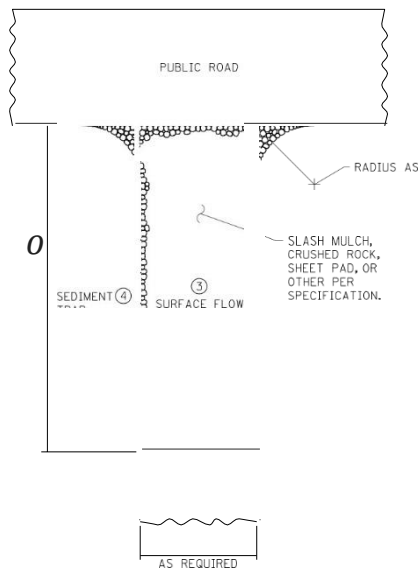

SLASH MULCH, CRUSHED ROCK, OR SHEET PAD CONSTRUCT 10 N EXT @@

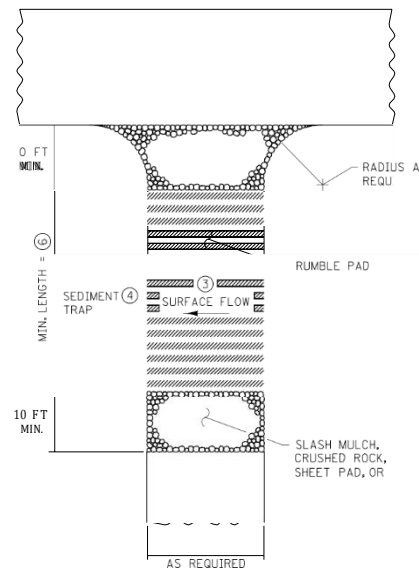

RUMBLE PAD CONSTRUCT 10 N EXT @@

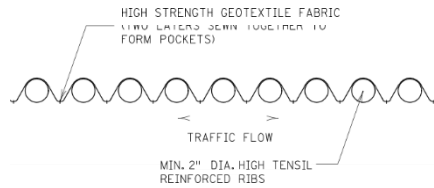
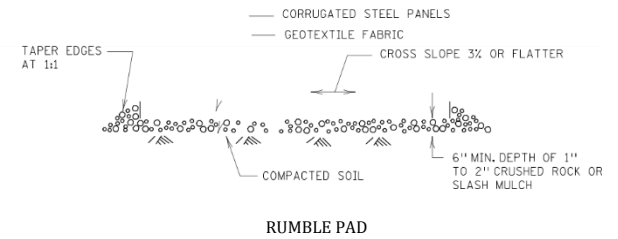

SHEET PAD

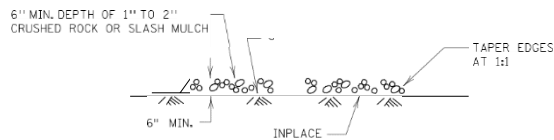

SLASH MULCH OR CRUSHED ROCK

- ① MINIMUM LENGTH SHALL BE THE GREATER OF 50 FEET OR A LENGTH SUFFICIENT TO
- ② PROVIDE RADIUS OR WIDEN PAD SUFFICIENTLY TO PREVENT VEHICLE TIRES FROM
- ③ IF RUNOFF FROM DISTURBED AREAS FLOWS TOWARD CONSTRUCTION EXITS, PREVENT RUNOFF FROM DRAINING DIRECTLY TO PUBLIC ROAD OVER CONSTRUCTION EXIT BY CROWNING THE EXIT OR SLOPING TO ONE SIDE. IF SURFACE GRADING IS INSUFFICIENT, PROVIDE OTHER MEANS OF INTERCEPTING RUNOFF.
- ④ IF RUNOFF FROM CONSTRUCTION EXITS WILL DRAIN OFF OF PROJECT SITE, PROVIDE
- ⑤ DRAIN THE WASH WATER TO A SEDIMENT TRAP.
- ⑥ MINIMUM LENGTH OF RUMBLE PAD SHALL BE 20 FEET, OR AS REQUIRED TO REMOVE SEDIMENT FROM TIRES. IF SIGNIFICANT SEDIMENT IS TRACKED FROM THE SITE, THE RUMBLE PAD SHALL BE LENGTHENED OR THE DESIGN MODIFIED TO PROVIDE
- ⑦ REMOVE CONSTRUCTION SEDIMENT FROM VEHICLE TIRES.
- ⑧ MAINTENANCE OF CONSTRUCTION EXITS SHALL OCCUR WHEN THE EFFECTIVENESS OF SEDIMENT REMOVAL HAS BEEN REDUCED. MAINTENANCE SHALL CONSIST OF REMOVING SEDIMENT AND CLEANING THE MATERIALS OR PLACING ADDITIONAL MATERIAL (SLASH MULCH OR CRUSHED ROCK) OVER SEDIMENT FILLED MATERIAL TO RESTORE

REVISION:  
 APPROVED: 2-28-2017  
  
 CHIEF ENVIRONMENTAL OFFICER

MINNESOTA DEPARTMENT OF TRANSPORTATION  
  
 STATE DESIGN ENGINEER

STABILIZED CONSTRUCTION EXIT  
 TEMPORARY SEDIMENT CONTROL

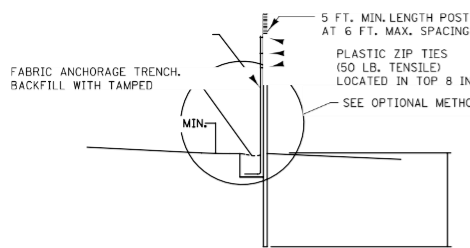

SILT FENCE TYPE HI @ HAND INSTALLED

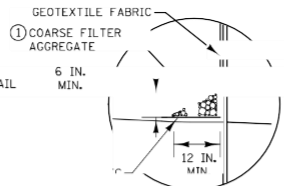

SILT FENCE TYPE MS @ DMA CHINE SLICED

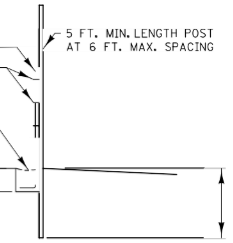
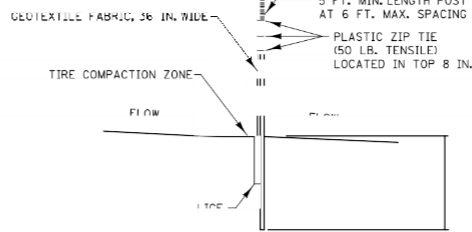

SILT FENCE TYPE PA @ (PREASSEMBLED)

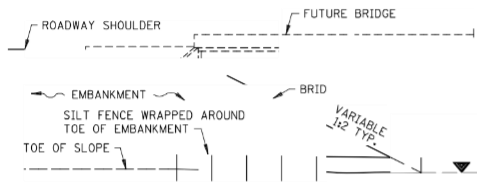

SILT FENCE ONLY

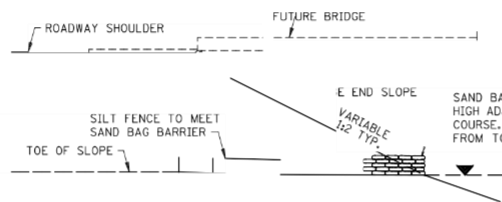

SILT FENCE WITH SAND BAGS

INSTALLATION AT BRIDGE EMBANKMENT ADJACENT TO WATER

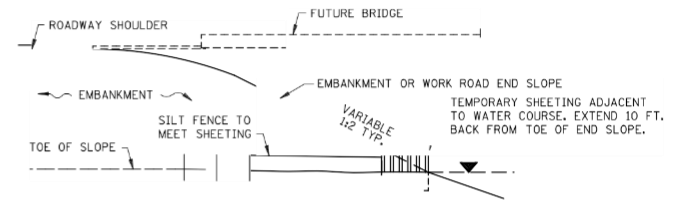

SILT FENCE WITH SHEETING

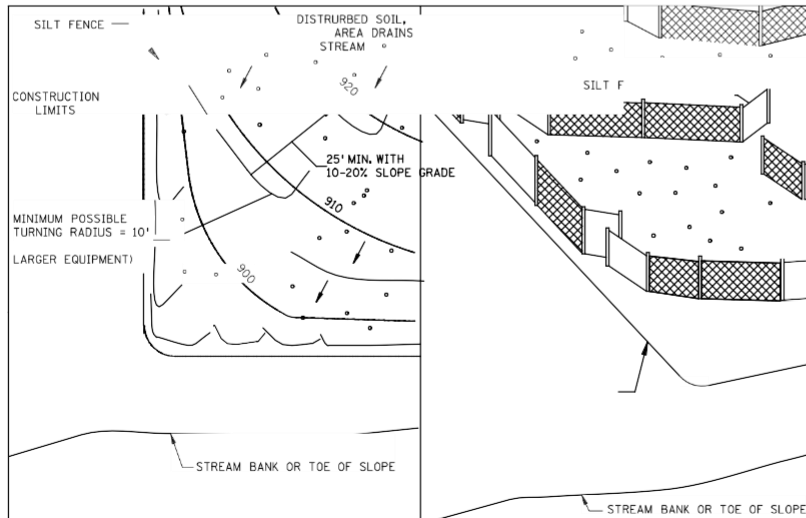

PLAN VIEW

PERSPECTIVE VIEW

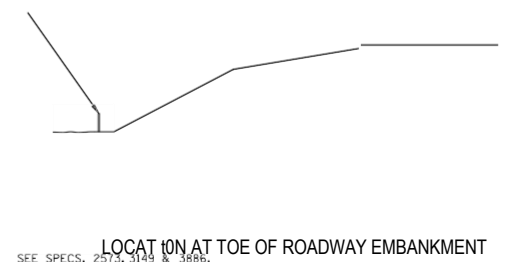

NOTES:

- ④ WATER COURSE FLOW VELOCITY: STANDING. CONTRIBUTING SLOPE AREA: 1.2 ACRE.
- ⑤ WATER COURSE FLOW VELOCITY: 1 TO 7 FT./SEC. CONTRIBUTING SLOPE AREA: 1 ACRE.
- ⑥ WATER COURSE FLOW VELOCITY: 8 TO 16 FT./SEC. CONTRIBUTING SLOPE AREA: 3 ACRES.

REVISION: \_\_\_\_\_  
APPROVED: 2-28-2017  
*Sup. CWL*  
CHIEF ENVIRONMENTAL OFFICER

**mn**  
MINNESOTA  
DEPARTMENT OF TRANSPORTATION  
*Tom Sika*  
STATE DESIGN ENGINEER

TEMPORARY SEDIMENT CONTROL

3-HOOK INSTALLATION

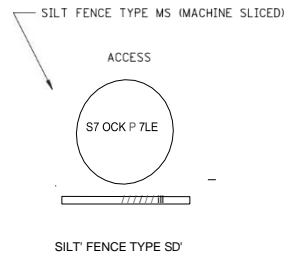
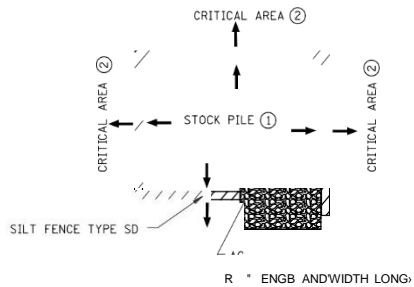
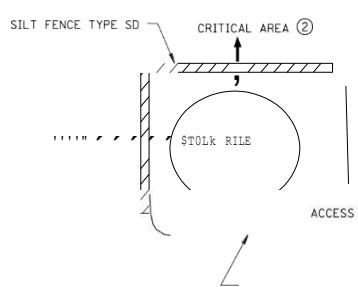

STOCK PILE SEDIMENT CONTROL

STOCK PILE CONTAINMENT

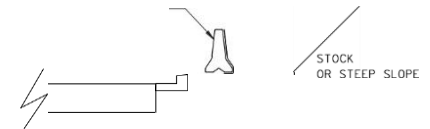
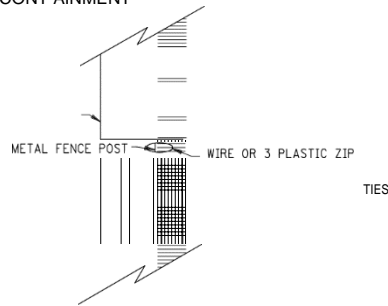
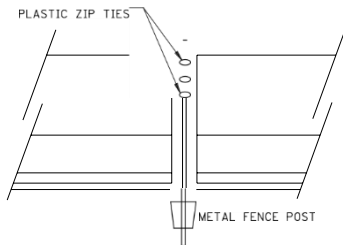

CURB AND GUTTER PROTECTION SYSTEM

SILT FENCE TYPE SD (SUPER DUTY) PROFILE VIEW WITHOUT LOOP BARS TOP VIEW

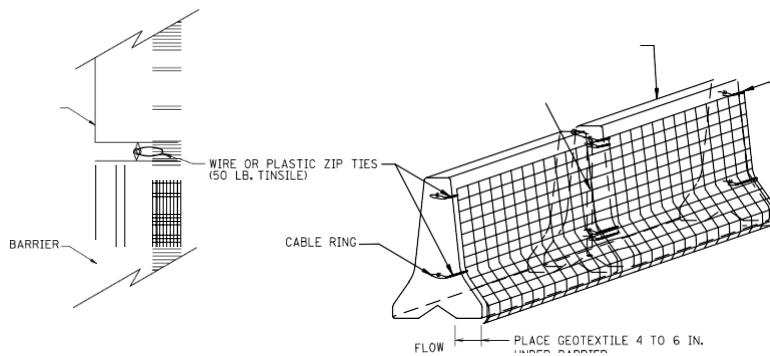

DITCH PROTECTION SYSTEM

SEE SPECS. 2533, 2573 & 3886.

SILT FENCE TYPE SD USED TO PROTECT CRITICAL AREAS FROM SHEET FLOW, AND AREAS WHERE OTHER

PLACE SILT FENCE TYPE SD ALONG A CONSTANT ELEVATION.

NOTES:

- ① PLACING STOCK PILES NEXT TO AN ENVIRONMENTALLY SENSITIVE AREA IS NOT RECOMMENDED. WHEN THERE ARE NO FEASIBLE ALTERNATIVES, PLACE SILT FENCE SD AS SHOWN OR AS DIRECTED BY THE ENGINEER.
- AREAS INCLUDE WETLANDS, JUDICIAL DITCHES, STREAMS, WATER BODIES, AND OTHER AREAS REQUIRING

APPROVED: 2-28-2017  
  
 CHIEF ENVIRONMENTAL OFFICER

MINNESOTA DEPARTMENT OF TRANSPORTATION  
  
 STATE DESIGN ENGINEER

SUPER DUTY SILT FENCE

TEMPORARY SEDIMENT CONTROL

TOP VIEW

PERSPECTIVE VIEW

SILT FENCE TYPE SD (SUPER DUTY) BARRIER WITH LOOP BARS



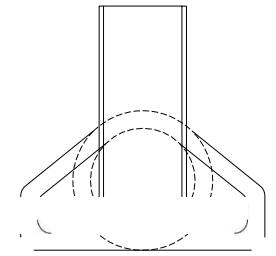
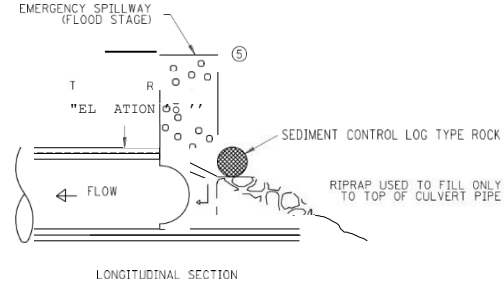
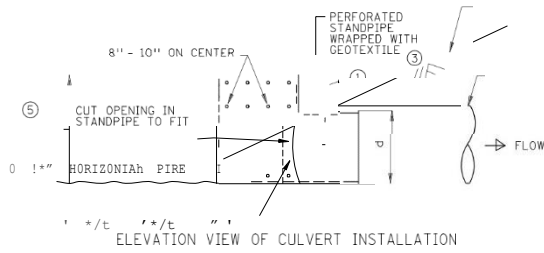
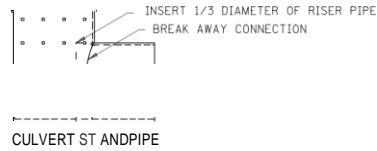
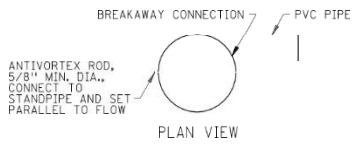

SEDIMENT CONTROL LOG TYPE ROCK

NOTE: SEDIMENT CONTROL LOG TYPE ROCK MAY BE WRAPPED AROUND RISER

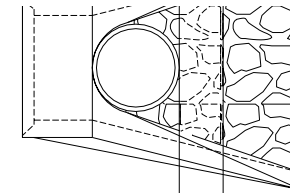

CULVERT STANDPIPE INSERT (D-RISER)

CULVERT STANDPIPE INSERT (D-RTSER)

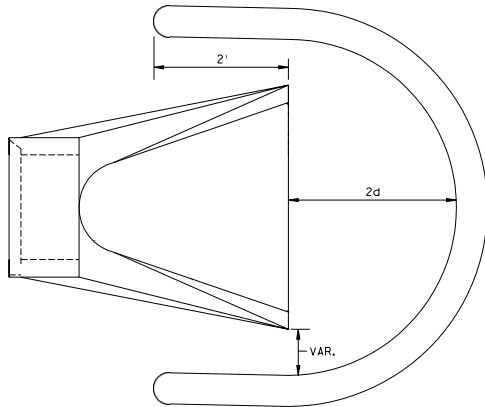

SEDIMENT CONTROL LOG WEIR  
(COMPOST, WOOD CHIP, OR ROCK)  
d = CULVERT SIZE: 12" - 36"

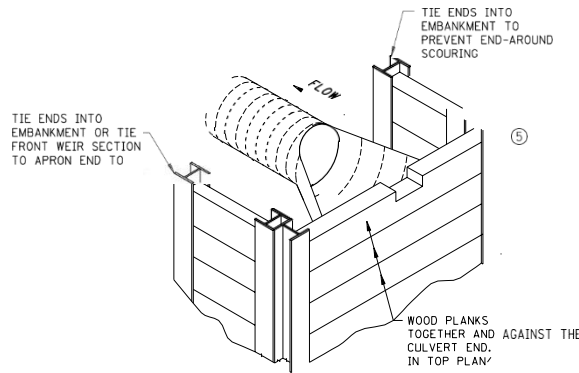

WOOD PLANK WEIR

**NOTES:**

SEE SRCS. 2573, 2891 & 3892.

① ROCK LOG OR SANDBAG TO HOLD STANDPIPE AND AS A SEAL BETWEEN RISER PIPE AND CULVERT.

ACT

MONOFILAMENT IN BOTH DIRECTIONS, MEETING SPEC. 3886

④ ROCK LOG OR RIP RAP TO HOLD STANDPIPE AND ACT AS A FILTER BETWEEN RISER PIPE AND CULVERT.

⑤ HEIGHT OVERFLOW NOT TO CAUSE FLOODING OF ROAD OR ADJACENT PROPERTIES.

REVISION:  
APPROVED: 2-28-2017  
*[Signature]*  
CHIEF ENVIRONMENTAL OFFICER

**mn**  
MINNESOTA  
DEPARTMENT OF TRANSPORTATION  
*[Signature]*  
STATE DESIGN ENGINEER

TEMPORARY SEDIMENT CONTROL

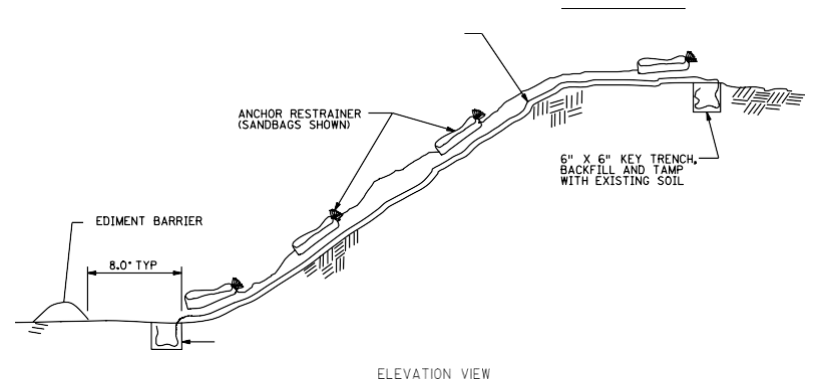
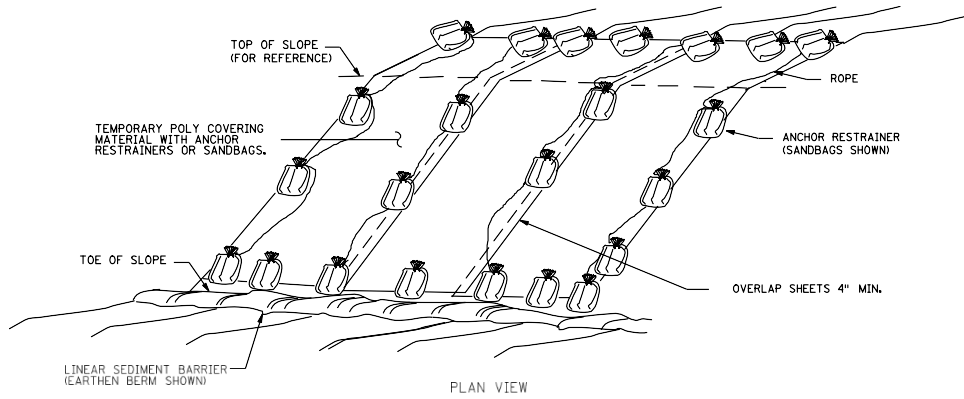

TEMPORARY POLY COVER ON SLOPE

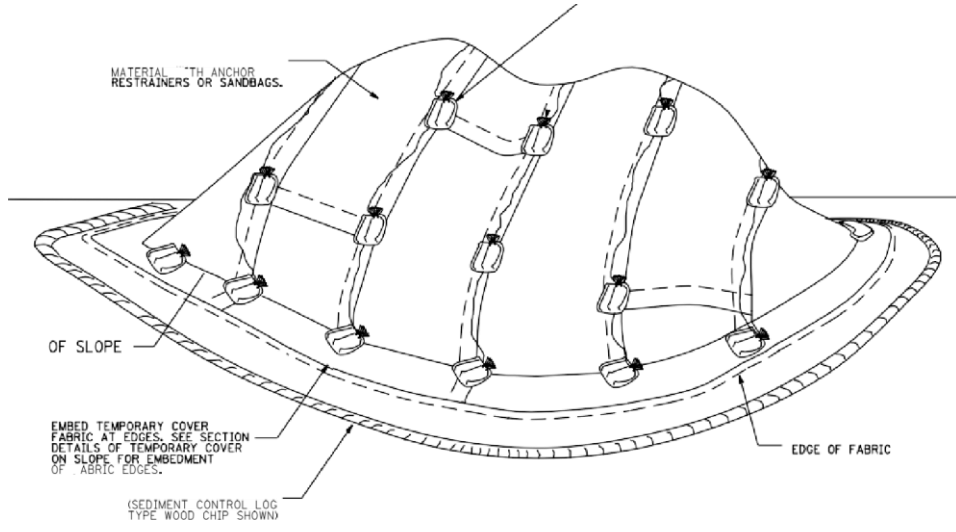

TEMPORARY POLY COVER ON STOCK PILE

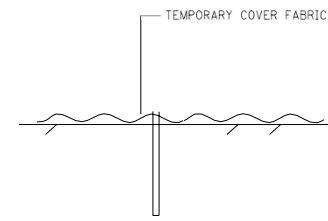

ANCHOR RESTRAINER (STEEL BAR AND WOODEN LATH OPTION)



STEEL REINFORCING BAR DETAIL

NOTES  
 ANCHOR RESTRAINERS: TYPE, QUANTITY, AND SPACING ARE INCIDENTAL TO POLY COVER. PROVIDE ON CORNERS AND SEAMS OF POLY COVER MATERIAL TO KEEP FROM BLOWING OFF. NO MINIMUM SPACING REQUIRED.  
 PERIMETER CONTROL: USE SEDIMENT CONTROL LOGS TYPE WOOD CHIP OR COMPOST, INCIDENTAL.

REVISION:  
 APPROVED: 2-28-2017  
*[Signature]*  
 CHIEF ENVIRONMENTAL OFFICER

**mn**  
 MINNESOTA  
 DEPARTMENT OF TRANSPORTATION  
*[Signature]*  
 STATE DESIGN ENGINEER

TEMPORARY EROSION CONTROL



**CONSTRUCTION STORMWATER PERMIT (CSP)**  
(Not required for Category 1 Land Disturbance)

City of Alexandria  
704 Broadway  
Alexandria, MN 56308  
(320) 763-6678 Telephone  
(320) 763-3511 Fax

Permit Number: \_\_\_\_\_  
Building Permit Number: \_\_\_\_\_  
Date Issued: \_\_\_\_\_

Site Information

Project Address: \_\_\_\_\_ Owners Name: \_\_\_\_\_

Project Name: \_\_\_\_\_ Project Type: \_\_\_\_\_ Acres to be Disturbed: \_\_\_\_\_

Natural Resource Feature within 100 feet: Yes  No  Storm Drain within 100 feet: Yes  No

If Yes, Identify Natural Resource Feature(s): \_\_\_\_\_

Proposed Start Date: \_\_\_\_\_ Proposed Completion Date: \_\_\_\_\_

Scope of Land Disturbance Activity:

- Category 2 Land Disturbance
- Category 3 Land Disturbance\*  
*\*Separate MPCA Construction Stormwater Permit Required*
- Part of Common Development Plan
- Site within 1 mile of Lake Winona

Best Management Practices

Areas not being actively worked to be stabilized within 14 days.  
 \*\*(Areas within 1 mile of Lake Winona 7 days)

Install/maintain perimeter controls and sediment barriers.  
 Keep discharge points and receiving waters free of sediment.  
 Protect natural resources (streams, wetlands, mature trees, etc).  
 Properly protect storm drain inlets.  
 Keep sediment from tracking onto street.  
 Keep trash/litter collected and contained.  
 Keep concrete washout areas clearly marked and maintained.  
 Keep fueling, cleaning, maintenance areas free of leaks and spills.  
 Keep potential stormwater contaminants inside or under cover.  
 Make sure previously disturbed areas are/remain stabilized.  
 Properly located and stabilize all stockpiles.  
 Check site for compliance after each ½-inch (+) rain event.

Party Responsible for Installing, Implementing and Maintaining Erosion and Sediment Control per Plan

Name: \_\_\_\_\_

- Operator/General Contractor
- Owner (if Owner is Operator/General Contractor)

Contact Person: \_\_\_\_\_

Address: \_\_\_\_\_

City: \_\_\_\_\_ State: \_\_\_\_\_ Zip: \_\_\_\_\_

Telephone: \_\_\_\_\_ Cell: \_\_\_\_\_

Email: \_\_\_\_\_

**GENERAL NOTES TO PERMITEE:**

The costs associated with an on-site review by the City Engineer of reported stormwater management violations will be the responsibility of the property owner. Re-inspections of Non-Compliant Erosion and Sediment Control BMPs will be subject to re-inspection fees and may result in a "stop work" order being issued to the site.

**CERTIFICATION STATEMENT**

I certify under penalty of law that this document and all attachments, to the best of my knowledge and belief, true, accurate and complete. I am aware that there are significant penalties for submitting false information, including the possibility of fine and imprisonment for knowing violations.

Print Name and Title: \_\_\_\_\_

Signature of Permit Holder: \_\_\_\_\_ Date: \_\_\_\_\_

Approved By: \_\_\_\_\_ Date: \_\_\_\_\_

## ***Final Inspection Checklist Worksheet*** **For Building Certificate of Occupancy**

### Synopsis of Required “Final” Inspections

1. The final fire alarm system testing and inspection must be scheduled with the installing contractor and the **Fire Chief**. In some instances, the State Fire Marshal may also want to be present. The installing contractor is responsible for installing and subsequently testing the entire alarm system in accordance with 2010-NFPA 72 and the 2015 State Building Code. A final alarm system installation certification form must then be completed, signed and submitted to the **Fire Chief** for final approval. A copy of this certification form must be [provided to the Building Official](#).
2. The final fire sprinkler system testing and inspection must be scheduled with the installing contractor and the **Fire Chief**. In some instances, the State Fire Marshal may also want to be present. The installing contractor is responsible for installing and subsequently testing the entire fire sprinkler system in accordance with 2010-NFPA 13 and the 2015 State Building Code. At the final inspection, the fire sprinkler system flow alarm will be tested to verify that it is tied into an automatic phone-dialer system that will send a flow-alarm signal to an approved monitoring firm. The installing contractor must also complete and submit a final fire sprinkler system installation certification form to the **Fire Chief** for final approval. A copy of this certification form must be [provided to the Building Official](#).
3. The final fire sprinkler system fire-pump start-up/operational test and final inspection must be scheduled with the installing contractor and the **Fire Chief**. In some instances, the State Fire Marshal may also want to be present. The installing contractor is responsible for installing and subsequently testing the entire fire-pump system in accordance with 2010-NFPA 13, 2010-NFPA 20, and the State Building and Fire Code. The installing contractor must complete and submit a final fire-pump operation certification form to the **Fire Chief** for final approval. A copy of this certification form must be [provided to the Building Official](#).
4. The final emergency generator system start-up/operational test and final inspection must be scheduled with the installing contractor and the **Fire Chief**. In some instances, the State Electrical Inspector and/or the State Fire Marshal may also want to be present. The installing contractor is responsible for installing and subsequently testing the generator system in accordance with the State Electrical Code, 2010-NFPA 110, 2010-NFPA 111, and the 2015 State Building Code. Documentation of this inspection must be [provided to the Building Official](#).
5. Class I kitchen hoods must be operationally tested by the installing contractor/building mechanical contractor and witnessed by the **Fire Chief**. Operational tests may include, but are not limited to: building power system shutdown to verify hood operation under fire suppression alarm conditions, smoke ventilation tests, grease duct pressure tests, power interconnection tests with required MAU, etc. The installing contractor is responsible for installing and subsequently testing the kitchen hood fire suppression system in accordance with MN Rule 1346, 2014-NFPA 96, and the State Building and Mechanical Codes. The fire suppression system installing contractor must also complete and submit a final system installation certification form to the **Fire Chief** for final approval. A copy of this certification must be [provided to the Building Official](#).

6. A final MDH health inspection must be completed on any public kitchen and/or food preparation area. This inspection must be scheduled with, and subsequently approved by, a Minnesota Department of Health Sanitarian, or the local health department sanitarian. This inspection must be completed and approved prior to occupancy and/or use of the kitchen and any food preparation area. A copy of the final health inspection approval must be [provided to the Building Official](#) prior to the final occupancy inspection of the building.
7. Every elevator, elevator equipment/control room, LULA lift, escalator, moving sidewalk, or chair lift must be inspected and approved by a CCLD State Elevator Inspector prior to being placed into operation and prior to the final building occupancy inspection. The installing contractor is responsible for scheduling all required elevator inspections with the CCLD Elevator Inspector(s). A copy of this approval must be [provided to the Building Official](#)
8. All high-pressure-piping [HPP] piping over 15 PSIG, all ammonia piping systems, all HPP/high-temp piping systems over 250 Degrees/30PSI, and all high-pressure boiler system installations must be inspected by the State High-Pressure-Piping Inspectors and/or a State Boiler Inspector - or their approved designate. The installing contractor is responsible for scheduling all required inspections for this equipment. Written verification of required final inspection(s) approval must be made available to the Building Official before final occupancy inspection of the building. Copies of all boiler equipment start-up reports must be [provided to the Building Official](#) prior to the final building inspection.
9. A final electrical inspection is required on all interior and exterior electrical system installation for the project. The installing contractor is responsible for scheduling all required electrical inspections. The final electrical inspection must be completed and approved by the assigned State or local Electrical Inspector. Written verification of required final inspection(s) approval must be [provided to the Building Official](#).
10. A final plumbing inspection is required on all interior and exterior plumbing system installations. The installing contractor is responsible for scheduling all required plumbing inspections. Final plumbing inspection(s) may include requirements for: hydrostatic testing of domestic water services, air tests on exterior sanitary and/or storm sewer piping, chlorination and subsequent flushing and bacterial testing of exterior water distribution systems, interior monometer testing, RPZ testing, potable water distribution system testing and subsequent chlorination and bacterial testing. (Also see items 18, 19, 20, and 21 for further requirements.) The installing contractor is responsible for scheduling all required inspections with the Building Department.
11. A final HVAC/mechanical system inspection is required on all interior and/or exterior building mechanical systems. The installing contractor is responsible for scheduling this inspection with the Building Inspector. Final HVAC/mechanical system inspection(s) may include requirements for: hydrostatic testing of building service piping, gas line air tests, smoke and/or fire damper actuation testing and inspection, smoke control system operational testing and inspection, fuel burning equipment start-up or air handling equipment operational testing and inspection, etc. (See items 12, 13, 14, and 18 for further requirements.) Written verification of required equipment test results must be [provided to the Building Official](#) before final inspection of the building.
12. Final fuel-burning equipment start-up inspection, testing, and certifications must be completed for each piece of fuel-fired equipment in the building. The installing contractor is responsible for completing and submitting final equipment start-up certificates/results (which may include requirements for ORSAT testing and/or equipment balancing) for each piece of equipment. Written verification of required final inspection(s) (and required test results) must be [provided to the Building Official](#) before final inspection of the building.

13. A final HVAC equipment balancing report must be submitted for the buildings' HVAC air handling system and all hydronic equipment. The installing contractor is responsible for scheduling and completing this testing. Final balancing reports and/or test results must be [provided to the Building Official](#) prior to final HVAC/Mechanical system inspection and prior to the final occupancy inspection of the building.
14. A final HVAC/Mechanical and Electrical systems "Commissioning Report" must be completed by either a third party commissioning agency, or by the project Architect, Mechanical, and Electrical Engineer(s). All new mechanical/electrical equipment for this project is to be tested and adjusted for verification of proper functionality and performance and to ensure that all control elements are calibrated and in proper working condition, all systems are balanced, and that all components, equipment, systems, and interfaces between systems, conform to the construction documents and the Minnesota Energy Code, IECC Section C408. A letter of final verification, or the CCLD Commissioning Form, evidencing such condition must be [provided to the Building Official](#) prior to final inspection of the building.
15. A final Special Inspection & Testing Summary report must be completed and provided to the Building Official once all required special inspections are done for the project. The final summary report must essentially state that all required special inspections/testing have been completed, tested, and/or inspected as required by the code and by the structural engineer and/or architect of record. It must also contain language to verify that said inspections and test results meet the building code and the project specification requirements. This report must be [provided to the Building Official](#) as soon as possible, but at a minimum, before the final occupancy inspection of the building.
16. All miscellaneous gas piping, medical gas piping, process piping, hydronic piping, plumbing piping, and other mechanical equipment piping must be pressure tested (and witnessed/verified by the appropriate state inspector) prior to the final occupancy inspection of the building. A copy of the third party medical gas test/inspection must be [provided to the Building Official](#) prior to final inspection of the building.
17. All exterior site-work utilities must be final tested/inspected by the City Engineer. Some of these tests/inspections include: Hydrostatic pressure testing, chlorination, flushing, bacterial water testing, air pressure tests on sanitary and storm sewer pipes, etc. The installing contractor is responsible for scheduling of all required inspections and/or tests for these items. All systems/equipment must be inspected and approved by the City Engineer prior to final inspection of the building.
18. Every septic system must be inspected and approved by the local authority prior to the final occupancy inspection of the building. It is the responsibility of the installing contractor to schedule and obtain all required septic system inspections (with the local authority) prior to the final occupancy inspection of the building.
19. Every water-well and every geothermal well must be inspected during its installation by the local authority and/or a State Well Inspector. The well installer is responsible for scheduling all required well inspections. A final water sample test must be completed prior to final occupancy inspection to verify water quality. A copy of the final water test report must be [provided to the Building Official](#) prior to final occupancy inspection of the building.
20. A final "zoning inspection" is required. It is the responsibility of the general contractor and/or construction manager to schedule all required local/jurisdictional final zoning inspections with City Planner, Mike Weber (320)-759-3626. These inspections should be completed/approved prior to final occupancy inspection. A copy of this approval [must be provided to the Building Official](#).



21. The final occupancy inspection must be completed prior to moving any furnishings into the building. It must also be completed and approved prior to occupancy of the building. All aforementioned final inspections must be completed and approved as outlined herein - prior to scheduling the final occupancy inspection. It is the responsibility of the general contractor and/or the construction manager to schedule the final building occupancy inspection. Upon successful completion of this inspection, a Certificate of Occupancy will be issued for new building construction. Building occupancy and use may then occur.
22. Other Inspections that may be deemed necessary will be identified during plan review of the project.

**Questions or comments regarding required final inspections, test reporting, or final submittals should be directed to:**

**Lynn Timm**  
**(320)759-3644**  
[ltimm@alexandriamn.city](mailto:ltimm@alexandriamn.city)

**Mike Schmidt**  
**(320)759-3639**  
[mschmidt@alexandriamn.city](mailto:mschmidt@alexandriamn.city)



Required Inspection	Date completed	<b>Final Inspection Checklist</b>	
		1	<b>Final fire alarm system inspection by the Fire Chief.</b> (Final 2010-NFPA 72 Alarm System Record of Completion form submittal required from installing contractor.)
		2	<b>Final fire sprinkler system testing and inspection by the Fire Chief. Auto-phone-dialer/monitoring system fully established.</b> (Final 2010-NFPA 13 Above Ground Material and Test Certification form submittal required from installing contractor.)
		3	<b>Final fire sprinkler system fire-pump start-up inspection by the Fire Chief.</b> (Final 2010-NFPA 13 and 2010-NFPA 20 Fire Pump Installation, Start-up and Flow Certification form submittal required from contractor.)
		4	<b>Final emergency generator start-up and operational inspection by Fire Chief and/or State Electrical Inspector.</b> (A final start-up and installation certification letter must be submitted by the installing contractor.)
		5	<b>Final class I kitchen hood operational inspection by Fire Chief.</b> (Final 2014-NFPA 96 installation and testing certification letter must be submitted to the state building inspector - by hood fire protection contractor.)
		6	<b>Final kitchen and/or food prep area sanitary health inspection.</b> (A copy of the final sanitarian/health inspection report must be submitted to the Building Official.)
		7	<b>Final elevator, LULA lift, escalator, or moving walk inspection by State Elevator Inspectors.</b>
		8	<b>Final high-pressure-piping, ammonia system piping and/or boiler inspection completed by the appropriate state or insurance inspector.</b> (A copy of the final boiler start-up reports must be submitted to the Building Official for final inspection.)
		9	<b>Final Electrical Inspection by State Electrical Inspector.</b>
		10	<b>Final Plumbing Inspection.</b>
		11	<b>Final Mechanical/HVAC inspection.</b>
		12	<b>Final fuel-burning-equipment start-up inspection, testing, and certification completed by the installing contractor(s).</b> (Final inspection/start-up forms are required for each piece of fuel burning equipment – to be submitted by the installing contractors at final mechanical/HVAC inspection.)
		13	<b>Final balancing report is required for each piece of mechanical equipment and/or the entire new HVAC system.</b> (A final balancing report must be submitted prior to or at the final project mechanical inspection.)
		14	<b>Final HVAC/MECH. and ELECTRICAL Systems “Commissioning Report” document from either a third party commissioning agency - or Equipment Commissioning Report signed-off by the project Architect, Mechanical and Electrical Engineer(s) is required to be submitted for final inspection (per the MN Commercial Energy Code, Section C408).</b> (All new mechanical/electrical equipment for this project must be tested and adjusted for verification of proper functionality and performance to ensure that all control elements are calibrated and in proper working condition, and that all components, equipment, systems, and interfaces between systems, conform to the construction documents and the energy code).
		17	<b>Final Special Inspection &amp; Testing Summary report completed and submitted to Building Official.</b> (From each respective project special inspection and testing agency.)
		18	<b>All gas piping, process piping, medical gas piping, mechanical equipment piping, plumbing piping, etc. - pressure tested and approved by the appropriate third party and/or inspector.</b> (A final medical gas piping inspection/approval report must be submitted by the respective third party inspection agency.)
		19	<b>Exterior site utilities final tested, inspected, sanitized, flushed, and approved - by City Engineer.</b>
		20	<b>Final septic system inspection for areas without sanitary sewer service required.</b>
		21	<b>Final well inspection by State MDH Well Inspector required.</b>
		23	<b>Final local zoning inspection approval – by the local zoning administrator.</b>
		24	<b>OTHER REQUIRED INSP: _____</b>
		25	<b>Final building Inspection for the Certificate of Occupancy</b> (All previously listed inspections and/or required paperwork must be completed and submitted to the Building Official prior to scheduling this inspection. The Certificate of Occupancy will not be issued until all required paperwork has been submitted.)

All above must be checked/completed prior to issuance of the Certificate of Occupancy. No furnishings may be placed within the building and no person shall occupy the building until a Certificate of Occupancy has been issued in accordance with MSBC 1300.0220.

NOTES:

---



---



---



---



---



---



---



---

Can it be demonstrated that the application of water constitutes a serious hazard to life?  Yes  No

Can it be demonstrated that the application of water constitutes a serious fire hazard?  Yes  No

Can it be demonstrated that the application of water constitutes a serious environmental hazard?  
 Yes  No

If the answers to any of the questions above are “Yes”, please explain in detail the specific conditions creating the serious hazard. **If** a serious hazard can be proven, the exemption to 1306 may be utilized.

---

---

---

Attach additional pages as may be necessary.

**OR**

Does the building have an adequate water supply?  Yes  No

**Definition of “adequate water supply”**: Sufficient groundwater or surface water of adequate quantity which will be continuously, legally, and physically available to satisfy the water needs of the proposed use, including the requirements set forth in NFPA 13.

If the answer to the question above is “Yes”, the provisions of 1306 requiring installation of fire sprinklers **will** apply. If the answer to the question above is “No”, explain why the building does not have an “adequate water supply” and proceed to the section below. Please be advised that economic considerations alone do not constitute a sufficient reason.

---

---

---

Attach additional pages as may be necessary.

**AND**

Is the building surrounded by public ways or yards more than 60-feet wide on all sides?  Yes  No

**If** an “adequate water supply” does not exist **AND** the building is surrounded on all sides by public ways or yards 60-feet, the exemption to 1306 may be utilized. If only one of these conditions exist, the provisions of 1306 requiring fire sprinklers **will** apply.

Upon review of the information provided and/or associated construction documents and/or discussion with owner/applicant/designer it has been determined that the fire sprinkler requirements set forth in Minnesota Chapter 1306 – Special Fire Protection Systems, **WILL / WILL NOT** require the installation of fire sprinklers within in the building to be constructed at \_\_\_\_\_ in Alexandria, Minnesota.

Water will be supplied by a **PUBLIC WATER SUPPLY / ALTERNATE ON-SITE SOURCE OF WATER.**

Automatic sprinkler systems must comply with the applicable standard referenced in the Minnesota State Building Code.

**Acknowledgement**

Signature of Owner/Owner's Representative: \_\_\_\_\_ Date: \_\_\_\_\_

Signature of Fire Marshal: \_\_\_\_\_ Date: \_\_\_\_\_

Signature of Building Official: \_\_\_\_\_ Date: \_\_\_\_\_