



Residential Permit Application

CITY

BUILDING PERMIT APPLICATION SUBMITTAL REQUIREMENTS, AS APPLICABLE

Two Complete Sets of Construction Plans, Drawn to Scale and Including:

- Foundation plan
- Floor plan; main, basement, garage and upper level(s), if applicable.
- Front, rear and side elevations
- Wall section
- Stair section with guardrail/handrail details
- A completed "Building Certificate" form to show how Energy Code Compliance will be achieved
- Special details, if any

Right of Way Permit Application (If applicable)

A Site Plan Drawn to 1:20 Scale Showing:

- North Arrow
- Lot Dimensions
- Location and Names of all Adjoining Streets
- Location of Easements
- Front, Side and Rear Yard Setbacks
- Driveway and Curb Openings; Location and Size
- Location and Size of Water, Sewer, and Electrical Services; Existing and Proposed
- Location of Structures in Relationship to Each Other, Property Line and Easements
- Dimensions of all Structures

Construction Stormwater Permit Application (Required for Category 2 and Category 3 Land Disturbing Activity)



BUILDING PERMIT APPLICATION

Address of Building Site:	Parcel Number:
----------------------------------	-----------------------

Legal Description:

Type of Improvement: <input type="checkbox"/> New <input type="checkbox"/> Alteration <input type="checkbox"/> Addition <input type="checkbox"/> Repair <input type="checkbox"/> Reroof <input type="checkbox"/> Raze <input type="checkbox"/> Move

Project Description:	Estimated Cost:
----------------------	------------------------

Applicant is: <input type="checkbox"/> Owner <input type="checkbox"/> Licensed Contractor <input type="checkbox"/> Architect/Engineer <input type="checkbox"/> Project Manager <input type="checkbox"/> Other

Property Owner Name:

Street Address:	City:	State:	Zip:
------------------------	--------------	---------------	-------------

Contact Person:	Telephone Number:	Email:
------------------------	--------------------------	---------------

Applicant Name:	License Number:
------------------------	------------------------

Street Address:	City:	State:	Zip:
------------------------	--------------	---------------	-------------

Contact Person:	Telephone Number:	Email:
------------------------	--------------------------	---------------

Contractor Name:	License Number:
-------------------------	------------------------

Street Address:	City:	State:	Zip:
------------------------	--------------	---------------	-------------

Contact Person:	Telephone Number:	Email:
------------------------	--------------------------	---------------

Designer Name:	License Number:
-----------------------	------------------------

Street Address:	City:	State:	Zip:
------------------------	--------------	---------------	-------------

Contact Person:	Telephone Number:
------------------------	--------------------------

Excavator Name:

Street Address:	City:	State:	Zip:
------------------------	--------------	---------------	-------------

Contact Person:	Telephone Number:
------------------------	--------------------------

Mechanical Contractor Name:

Street Address:	City:	State:	Zip:
------------------------	--------------	---------------	-------------

Contact Person:	Telephone Number:
------------------------	--------------------------

Plumbing Contractor Name:

Street Address:	City:	State:	Zip:
------------------------	--------------	---------------	-------------

Contact Person:	Telephone Number:
------------------------	--------------------------

Signature of Applicant or Agent _____ **Date** _____

Category 1 and Category 2 Land Disturbing Activity shall comply with the Minnesota Pollution Control Agency's Best Management Practices (BMPs).

The purpose of requiring this information as a part of the building permit application process is to minimize both short-term and long-term erosion, contain sediment on site and manage post construction runoff.

The Following Land Disturbing Activities Require an Erosion and Sediment Control Plan Sketch.

- Category 1** - Construction activities disturbing less than ½ acre that include new construction, demolition, remodel/addition, accessorial structure and/or landscaping/retaining walls.

The Following Land Disturbing Activities Require a Stormwater Management Plan.

- Category 2** – Construction disturbing equal to or greater than ½ acre, but less than 1 acre; or construction on riparian lake lots (except attached decks and 2015 Minnesota Building Code, Section 1300.0120, Subp. 4. Work Exempt from Permit); or construction that is determined by the City Engineer to present a substantial risk to neighboring private properties, public infrastructure or waterways/wetlands.
- Category 3** – Construction activities disturbing equal to or greater than 1 acre. (Also requires separate MPCA Construction Stormwater Permit)

Category 1 Plan Requirements:

- **The Following Must be Included in or Attached to the Plan Sketch**

- Location and type of perimeter erosion control
- Proposed construction exit location and material that it will be constructed of
- Location and type of other erosion prevention and sediment control BMPs
- Location and type of inlet protection for all storm sewer inlets downstream of the site within one block or as directed by City Engineer
- Name, telephone number and email address of individual responsible for the site and maintenance of the erosion and sediment controls
- Spot elevations (using an assumed datum) at:
 - Street edge at center of driveway
 - Existing ground within 10' radius of lot corners
 - Existing ground defining areas of steeper than 3:1 slopes
- Plan elevations (using an assumed datum) at:
 - Garage Floor
 - Top of House Foundation
 - Basement Floor
- Standard illustrations (details) of proper installation of erosion prevention and sediment control BMPs (MnDOT details provided for reference, pages 7-15)

- **The Following Notes Must be Placed on Plan Sketch and Adhered to as Applicable:**

- The street shall be swept clean before the end of each day of active construction, when sediment is tracked onto the street.
- Areas with slopes greater than 3:1 and areas adjacent to wetlands/waterbodies disturbed during construction shall be protected with temporary vegetation, mulching or other means as soon as practical.
- All exposed soil areas shall be stabilized as soon as practical.
- Unworked soils that remain exposed and not in use for longer than 14-days shall be seeded with temporary seed (grass, oats or wheat) in addition to being stabilized.
- No concrete washout shall occur on site unless it is done with an approved MPCA device or standard.
- Stockpiles shall be stabilized and surrounded with adequate perimeter control to prevent sedimentation.
- Inlet protection for all storm sewer inlets downstream and within one block of the site shall be installed and maintained.
- Site shall be kept clean at all times and refuse properly controlled.
- Temporary pumping shall not be permitted without use of an approved MPCA device or standard.
- Soil compaction shall be minimized.
- All temporary synthetic BMPs to be removed upon permanent stabilization.

Category 1 Erosion and Sediment Control Plan Sketch

(This page is **not** required for Category 2 or Category 3)

Please Show:

- Location and type of perimeter control
- Location and type of construction exit
- Location and type of other erosion prevention and sediment control BMPs
- Location and type of inlet protection for all storm sewer inlets within 1 block downstream
- Name, telephone number and email address of individual responsible for the site and maintenance of the erosion and sediment controls.
- Spot elevations (see list on page 3)
- Standard illustrations (details) of proper installation of erosion prevention and sediment control BMPs

- The street shall be swept clean before the end of each day of active construction, when sediment is tracked onto the street.
- Areas with slopes greater than 3:1 and areas adjacent to wetlands/waterbodies disturbed during construction shall be protected with temporary vegetation, mulching or other means as soon as practical.
- All exposed soil areas shall be stabilized as soon as practical.
- Unworked soils that remain exposed and not in use for longer than 14-days shall be seeded with temporary seed (grass, oats or wheat) in addition to being stabilized.
- No concrete washout shall occur on site unless it is done with an approved MPCA device or standard.
- Stockpiles shall be stabilized and surrounded with adequate perimeter control to prevent sedimentation.
- Inlet protection for all storm sewer inlets downstream and within one block of the site shall be installed and maintained.
- Site shall be kept clean at all times and refuse properly controlled.
- Temporary pumping shall not be permitted without use of an approved MPCA device or standard.
- Soil compaction shall be minimized.
- All temporary synthetic BMPs to be removed upon permanent stabilization.

□ **Category 2 Plan Requirements:**

- Two sets of clearly legible copies of permit submittals and required information shall be submitted to the City and shall be accompanied by all appropriate fees.
- Drawings prepared at a minimum scale of 1 inch equals 50 feet.
- Project name and date of preparation.
- Names, addresses and phone numbers of the land surveyor, and engineer, if any.
- Project description including property boundaries, areas to be disturbed, and the nature and purpose of the land disturbing activity and the amount of grading involved.
- Spot elevations of proposed grades in relation to existing grades on the subject property and adjacent properties.
- Existing site conditions including topography, vegetation and drainage arrows.
- Areas where finished slope will be steeper than 5:1.
- Critical erosion areas including areas on the site that have potential for erosion problems.
- Erosion and sediment control devices including methods to be used to control erosion on the site, both during and after the construction process.
- Location of storm drains, wetlands, sediment ponds and lakes.
- Location of material stockpiles.
- Plan for temporary site stabilization.
- Permanent stabilization including how the site will be stabilized after construction is completed, including specifications.
- Construction Stormwater Permit coverage terminates if the structures are finished and temporary erosion prevention and downgradient perimeter control is complete, and the permittee provides the MPCA's "Homeowner Fact Sheet" to the homeowner.
- Temporary rock exit location.
- Name of individual responsible for installation and maintenance of control devices, including a schedule of regular inspections and repair of erosion and sediment control structures.
- Adjacent areas including neighboring streams, roads, residential areas, etc. which might be affected by the land disturbing activity.
- Project schedule including a projected timeframe for completion of all site activities.
- Phasing of construction including the nature and purpose of the land disturbing activity, utilities, and building construction.
- Provisions for the removal of temporary synthetic erosion prevention and sediment control BMPs upon establishment of permanent vegetation.
- Surveyed Elevations (using North American Vertical Datum of 1988) at:
 - Benchmark
 - Street edge at center of driveway
 - Existing ground within 10' radius of lot corners
 - Existing ground defining areas of steeper than 3:1 slopes
- Plan elevations (using assumed datum) at:
 - Garage Floor
 - Top of House Foundation
 - Basement Floor
- Standard illustrations (details) of proper installation of erosion prevention and sediment control BMPs (MnDOT details provided for reference, pages 11-19).

Category 3 Plan Requirements:

All projects disturbing equal to or greater than **1 acre** must obtain a permit from the MPCA to discharge stormwater associated with construction activity. This permit requires preparation of a SWPPP which details erosion control practices, sediment control practices, dewatering and basin draining, inspection and maintenance, final stabilization and permanent stormwater management.

A pre-construction meeting, preferably at the construction site, including the operator/general contractor, the site grading contractor, the City of Alexandria Stormwater Inspector, and (if feasible) the owner or owner's representative and the individual preparing the SWPPP shall take place prior to start of construction.

Please submit all the above information at the time of CSP application.

**CITY OF ALEXANDRIA
Building Department 704 Broadway
Alexandria, MN 56308
(320) 763-6678 – Phone / (320) 763-3511 – Fax**

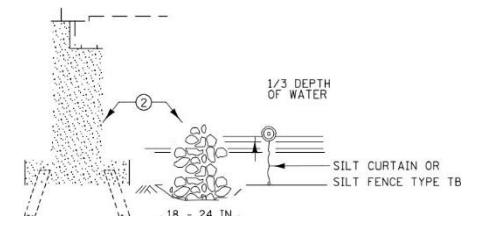
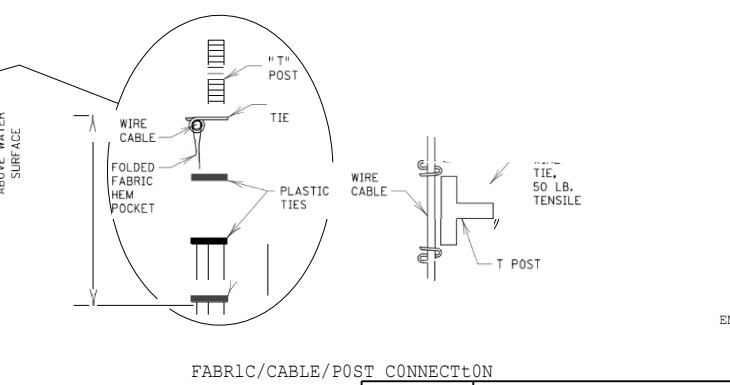
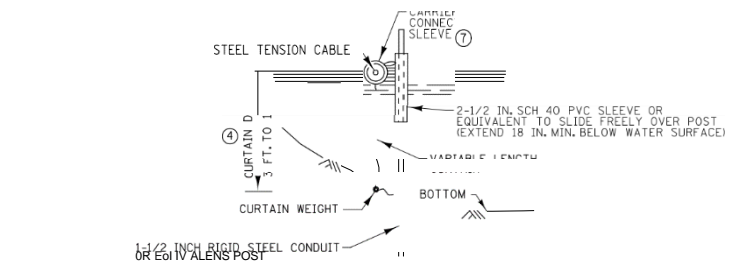
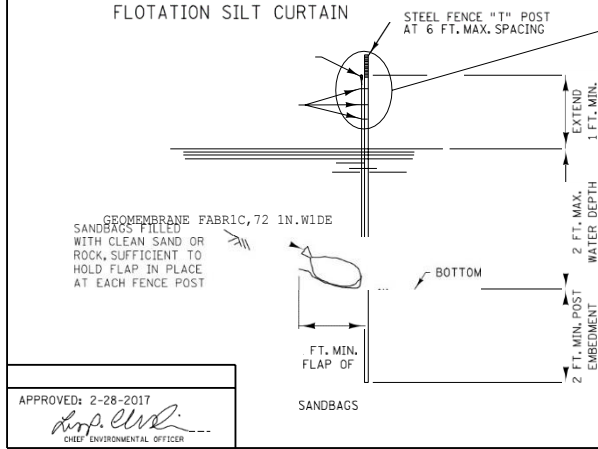
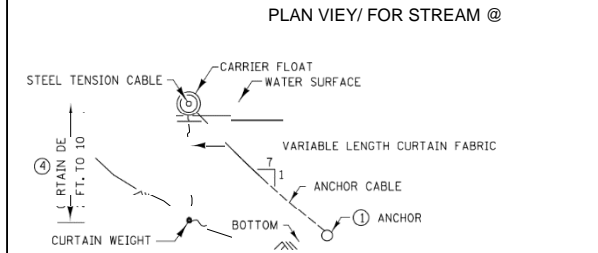
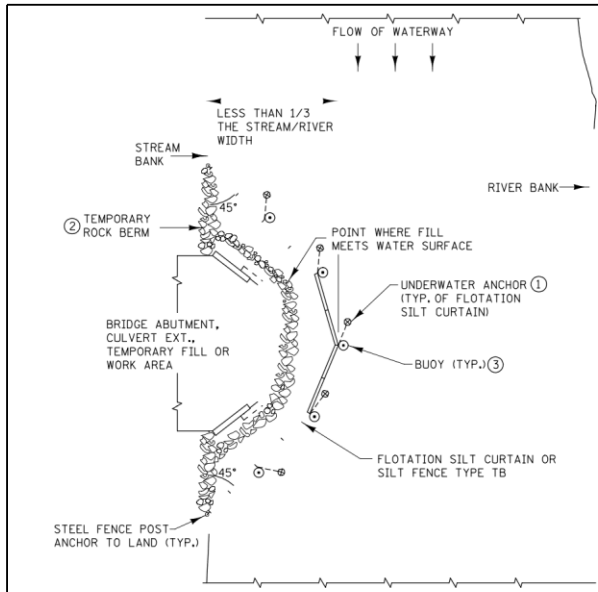

INSTALLATION GUIDELINES
FLOTATION SILT CURTAIN
TYPE: STLL WATER

INSTALLATION GUIDELINES
FLOTATION SILT CURTAIN
TYPE: MOVING WATER

INSTALLATION GUIDELINES
FLOTATION SILT CURTAIN
TYPE: STLL WATER

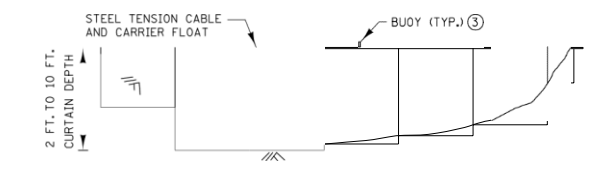

- NOTES:
- SEE SPCS 2573, 3886, 3887 & 3893
 - IN AREAS WHERE THE PLAN CALLS FOR RIPRAP AT A BRIDGE, CULVERT, OR SLOPE, A TEMPORARY RIPRAP ANCHOR SPACING AND WEIGHT REQUIREMENTS. SEE SPEC. 2573. WHEN THE WORK IS COMPLETE THE RIPRAP CAN THEN BE MOVED TO THE PERMANENT LOCATION INDICATED IN THE PLANS. THE TEMPORARY ROCK BERM IS INCIDENTAL.
 - ON U.S. COAST GUARD OR OTHER MOTORIZED WATERWAYS, BUOYS ARE REQUIRED TO MARK THE ENDS AND SPECIAL AREAS FOR VISIBILITY. PLACE BUOYS AS REQUIRED FOR NAVIGATIONAL PURPOSES.
 - MINIMUM WATER DEPTH APPLIES TO THE DEEPEST POINT ALONG THE FLOTATION SILT CURTAIN OR SILT FENCE TYPE TB FOR DETERMINING APPLICABILITY OF FLOTATION SILT CURTAIN OR SILT FENCE TYPE TB.
 - SILT CURTAIN SHOULD BE REMOVED WHEN THE AREA CONTRIBUTING DIRECT RUNOFF HAS BEEN TEMPORARILY OR PERMANENTLY STABILIZED. SILT CURTAIN SHOULD ALSO BE REMOVED BEFORE WINTER IF ICE UP OR ICE FLOW IS ANTICIPATED.
- BUT IN NO CASE SHALL EMBEDMENT BE LESS THAN 2 FEET.
EMBED POST INTO BOTTOM A MINIMUM OF 40% OF THE WATER DEPTH (INCLUDING WAVE HEIGHT)
- ANCHOR FLOAT MUST BE CONNECTED SECURELY TO SLEEVE WITH A MINIMUM TENSILE STRENGTH OF 100 LBS. CONNECTION METHOD MUST ALLOW FOR SLEEVE TO MOVE FREELY ON POST.
- PROVIDE SUFFICIENT NUMBER OF POST ANCHORS TO MAINTAIN SILT CURTAIN POSITION.

APPROVED: 2-28-2017
[Signature]
CHIEF ENVIRONMENTAL OFFICER

m
STATE DESIGN ENGINEER
APPROVED: *[Signature]*

TEMPORARY SEDIMENT CONTROL

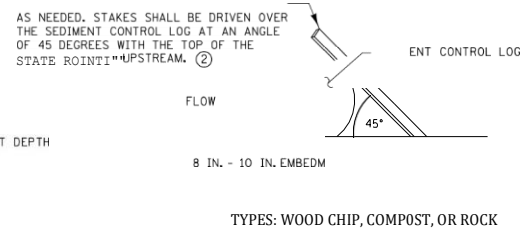
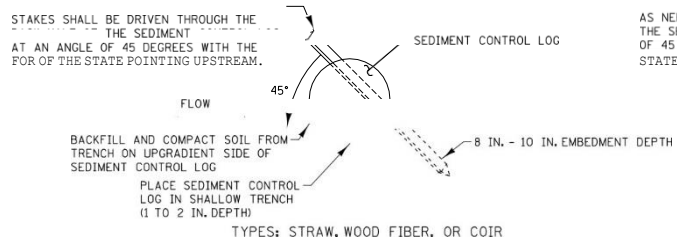

SEDIMENT CONTROL LOGS

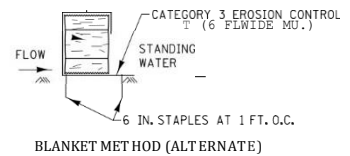
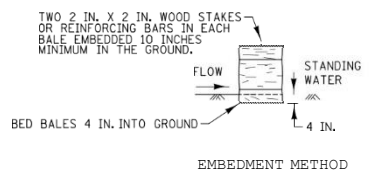
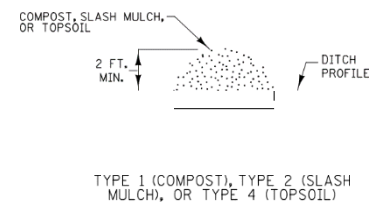
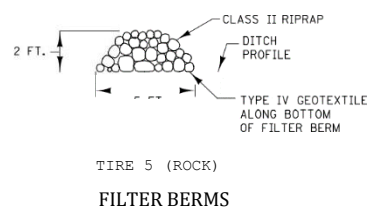
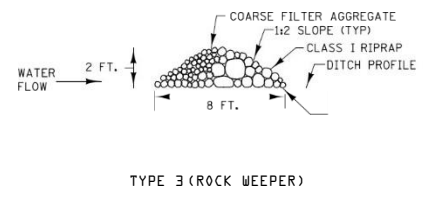

BALE BARRIERS @

NOTES:

- SEE SPECS. 2573, 314 9.5874, 3882, 3886, & 5897.
- SRAOF BETWEEN STATES SHALL BE A MAXIMUM OF 1 FOOT FOR DITCH CHECKS OR 2 FEET FOR PLACEMENT AS NEEDED TO PREVENT MOVEMENT OF SEDIMENT CONTROL LOGS PLACED ON
- (3) TO BE USED FOR CRITICAL PERIMETER CONTROL AREAS WHERE STANDING WATER OCCURS (6 INCH MAX. DEPTH). BALES SHALL CONSIST OF TYPE 1 MULCH OF APPROXIMATELY 14 IN. X 18 IN. X 36 IN. LONG. BALES SHALL BE PLACED ON EDGE AND BUTTED TIGHT TO ADJACENT BALES.
- INSTEAD OF TRENCHING, PLACE BALE ON THE BLANKET AND *RAP BLANKET AROUND THE BALE PLACE STAKE THROUGH BALE AND BLANKET.

APPROVED: 2-28-2017

 CHIEF ENVIRONMENTAL OFFICER

MINNESOTA DEPARTMENT OF TRANSPORTATION

 STATE DESIGN ENGINEER

APPROVED: 2-28-2017

TEMPORARY SEDIMENT CONTROL
 STANDARD PLAN 5-29T.405 2 OF 8

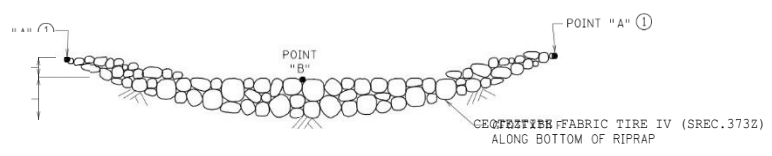

ROCK DITCH CHECKS
FILTER BERMS TYPE 3 (ROCK WEEPER) OR FILTER TYPE 5 (ROCK) @ @
 (FOR USE ON ROUGH GRADED AREAS)

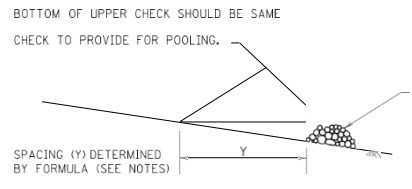

DITCH CHECK SPACING
 (FOR ALL FILTER BERM TYPES)

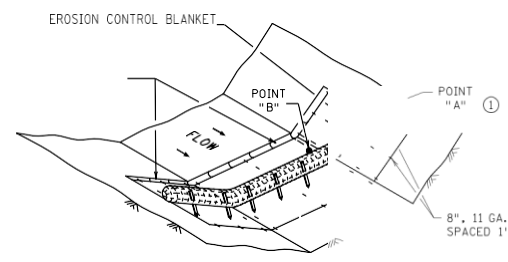

EROSION CONTROL BLANKET ANCHOR TRENCH. BACKFILL WITH TAMPED NATURAL SOIL.

8", 11 GA. STAPLES SPACED 1' 0" ON CENTER

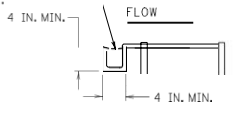

1 IN. X 2 IN. X 24 IN. LONG WOODEN STAKES AT 1 FT. MAXIMUM SPACING. STAKES SHALL BE DRIVEN THROUGH THE BACK HALF OF THE SEDIMENT CONTROL LOG AT AN ANGLE OF 45 DEGREES WITH THE TOP OF THE STAKE POINTING UPSTREAM.

SEDIMENT CONTROL LOG TYPE WOOD FIBER



EROSION CONTROL BLANKET CATEGORY 3 (8 FT. MIN. WIDTH)

STAPLE BLANKET IN ROWS WITH 6 IN. STAPLES AT 18 IN. MAX SPACING WITHIN ROWS AND 2 FT. MAX SPACING BETWEEN ROWS. LEADING AND TRAILING EDGE SHALL BE STAPLED APPROX. 6 IN. FROM EDGE (TYP.)

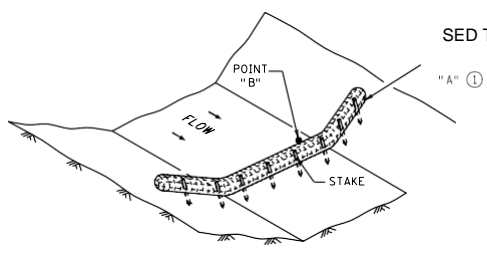

SEDIMENT CONTROL LOG TYPE BLANKET SYSTEM

FOR DITCH CHECKS, PLACE SEDIMENT CONTROL LOG PERPENDICULAR TO FLOW AND IN A CRESCENT SHAPE WITH THE CURVED EDGE UPSTREAM.
 APPROXIMATE SPACING BETWEEN EACH DITCH CHECK SHOULD BE DETERMINED FROM THE FOLLOWING SPACING FORMULA:

- ① POINT "A" MUST BE A MINIMUM OF 6 INCHES HIGHER THAN POINT "B" TO ENSURE THAT WATER FLOWS OVER THE
- ② PERMANENT ROCK DITCH CHECKS PLACED WITHIN THE CLEAR ZONE ARE TO BE 18" OR LESS IN HEIGHT. A 1:6 APPROACH AND DEPARTURE SLOPE SHALL BE PROVIDED.
- ④ DITCH GRADE 1.5% - 3%, MAX. FLOW VELOCITY 4.5 FT./SEC..
- ⑤ DITCH GRADE 1.5% - 3%, MAX. FLOW VELOCITY 1.5 FT./SEC..

SEDIMENT CONTROL LOG TYPE WOOD FIBER, OR TYPE COMPOSTS

REVISION: _____
 APPROVED: 2-28-2017

 CHIEF ENVIRONMENTAL OFFICER

MINNESOTA DEPARTMENT OF TRANSPORTATION

 STATE DESIGN ENGINEER

TEMPORARY SEDIMENT CONTROL

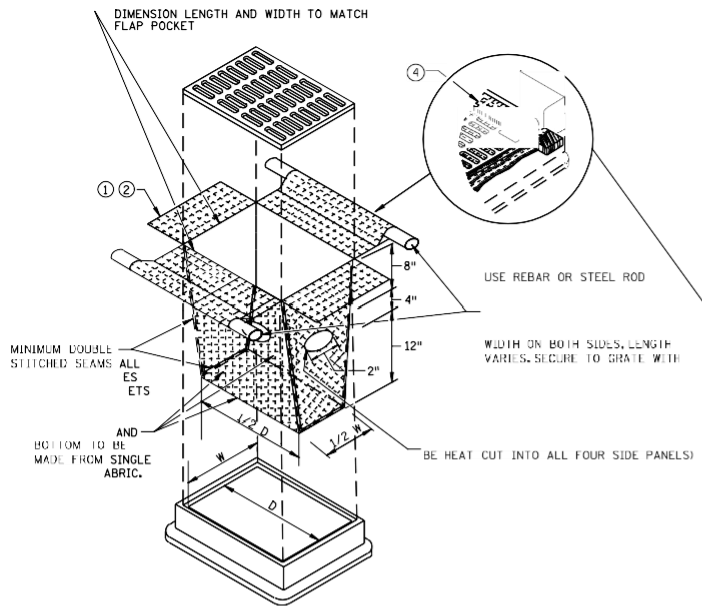

FILTER BAG INSERT @

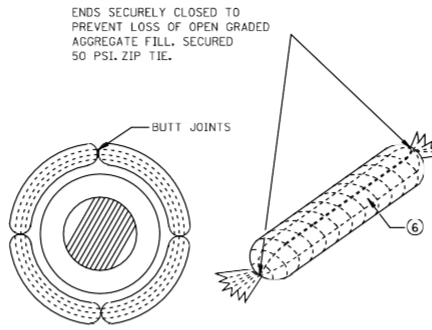

ROCK LOG/COMPOST LOG

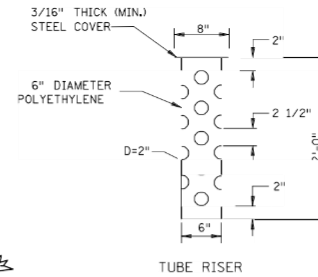

TUBE RISER

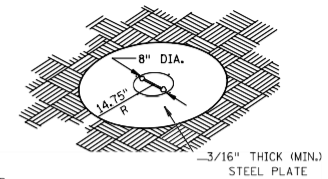

PERSPECTIVE VIEW

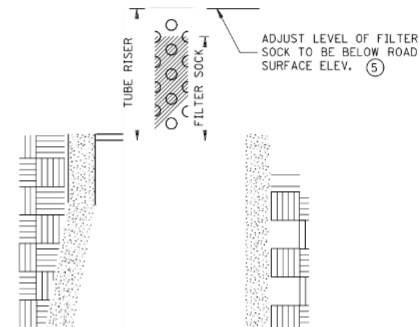

SECTION (UP POSITION)

SECTION (DOWN POSITION)

POP-UP HEAD

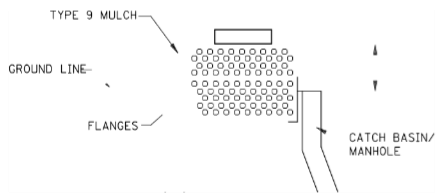

SEDIMENT CONTROL INLET HAT

NOTE:
THE SEDIMENT CONTROL BARRIER SHALL BE A METAL OR PLASTIC/POLYETHYLENE RISER SIZED TO FIT INSIDE THE CATCH BASIN/MANHOLE; HAVE PERFORATIONS TO ALLOW FOR WATER INFILTRATION; HAVE AN OVERFLOW OPENING, FLANGES AND A LID/COVER.

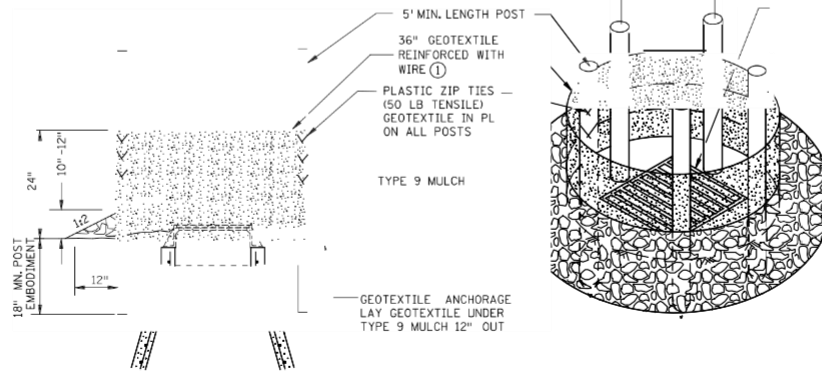

SILT FENCE RING AND ROCK FILTER BERM

USE WHERE INLET DRAINS IN AN AREA WITH SLOPES AT 1:3 OR LESS

NOTES:

DEVICES MUST BE ADJUSTED ACCORDINGLY AS TO NOT CAUSE FLOODING ON ROADWAY

- ① ALL GEOTEXTILE USED FOR INLET PROTECTION SHALL BE MONOFILAMENT IN BOTH DIRECTIONS, MEETING SPEC. 3BB6.
- ② FINISHED SIZE, INCLUDING POCKETS HERE REQUIRED SHALL EXTEND A MINIMUM OF 10 INCHES AROUND THE PERIMETER TO FACILITATE MAINTENANCE OR REMOVAL.
- DO NOT PLACE FILTER BAG INSERT IN INLETS SHALLOWER THAN 30 INCHES. PLACED BAG SHALL HAVE A MINIMUM SIDE CLEARANCE OF 3 INCHES BETWEEN TO ACHIEVE THE 3 INCH SIDE CLEARANCE.
- ④ FLAP POCKETS SHALL BE LARGE ENOUGH TO ACCEPT WOOD 2 INCH X 4 INCH OR USE A ROCK SOCK OR SAND BAGS IN PLACE OF THE FLAP POCKETS.
- ⑤ SOCK HEIGHT MUST NOT BE SO HIGH AS TO SLOW DOWN WATER FILTRATION TO CAUSE

GEOTEXTILE SOCK BETWEEN 4-10 FEET LOGO AND 4-6 INCH DIAMETER. SEAM TO BE JOINED BY TWO ROWS OF STITCHING WITH A PLASTIC MESH BACKING OR PROVIDE A COARSE AGGREGATE CONFORMING TO SPEC. 5157 TABLE 5157-1; CA-3 GRADATION.

APPROVED: 2-28-2017
[Signature]
CHIEF ENVIRONMENTAL OFFICER

MINNESOTA
DEPARTMENT OF TRANSPORTATION
[Signature]
STATE DESIGN ENGINEER

APPROVED: 2-28-2017

TEMPORARY SEDIMENT CONTROL

STANDARD PLAN 5-29T.405

4 OF 8

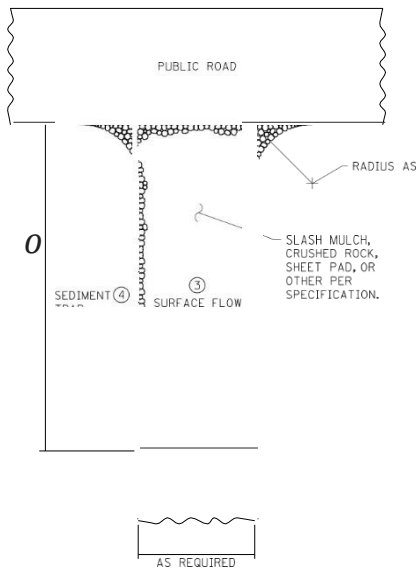

SLASH MULCH, CRUSHED ROCK, OR SHEET PAD CONSTRUCT 10 N EXT @ @

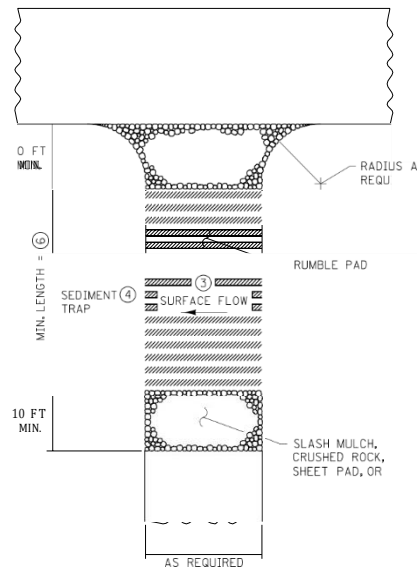

RUMBLE PAD CONSTRUCT 10 N EXT @ @

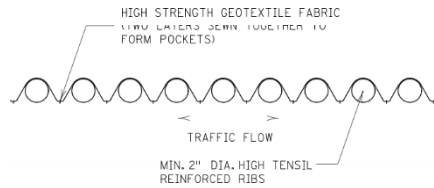
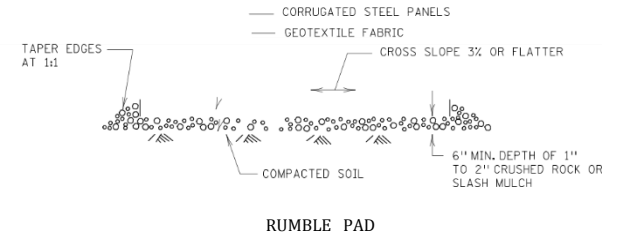

SHEET PAD

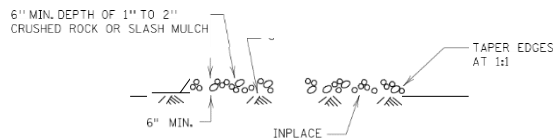

SLASH MULCH OR CRUSHED ROCK

- ① MINIMUM LENGTH SHALL BE THE GREATER OF 50 FEET OR A LENGTH SUFFICIENT TO
- ② PROVIDE RADIUS OR WIDEN PAD SUFFICIENTLY TO PREVENT VEHICLE TIRES FROM
- ③ IF RUNOFF FROM DISTURBED AREAS FLOWS TOWARD CONSTRUCTION EXITS, PREVENT RUNOFF FROM DRAINING DIRECTLY TO PUBLIC ROAD OVER CONSTRUCTION EXIT BY CROWNING THE EXIT OR SLOPING TO ONE SIDE. IF SURFACE GRADING IS INSUFFICIENT, PROVIDE OTHER MEANS OF INTERCEPTING RUNOFF.
- ④ IF RUNOFF FROM CONSTRUCTION EXITS WILL DRAIN OFF OF PROJECT SITE, PROVIDE
- DRAIN THE WASH WATER TO A SEDIMENT TRAP.
- ⑥ MINIMUM LENGTH OF RUMBLE PAD SHALL BE 20 FEET, OR AS REQUIRED TO REMOVE SEDIMENT FROM TIRES. IF SIGNIFICANT SEDIMENT IS TRACKED FROM THE SITE, THE RUMBLE PAD SHALL BE LENGTHENED OR THE DESIGN MODIFIED TO PROVIDE
- REMOVE CONSTRUCTION SEDIMENT FROM VEHICLE TIRES.
- ⑦ MAINTENANCE OF CONSTRUCTION EXITS SHALL OCCUR WHEN THE EFFECTIVENESS OF SEDIMENT REMOVAL HAS BEEN REDUCED. MAINTENANCE SHALL CONSIST OF REMOVING SEDIMENT AND CLEANING THE MATERIALS OR PLACING ADDITIONAL MATERIAL (SLASH MULCH OR CRUSHED ROCK) OVER SEDIMENT FILLED MATERIAL TO RESTORE

REVISION:
APPROVED: 2-28-2017
[Signature]
CHIEF ENVIRONMENTAL OFFICER

mn
MINNESOTA
DEPARTMENT OF TRANSPORTATION
[Signature]
STATE DESIGN ENGINEER

STABILIZED CONSTRUCTION EXIT
TEMPORARY SEDIMENT CONTROL

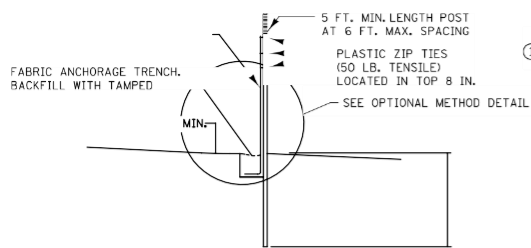

SILT FENCE TYPE HI @ (HAND INSTALLED)

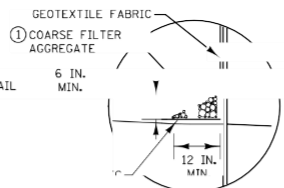

SILT FENCE TYPE MS @ (DMA CHINE SLICED)

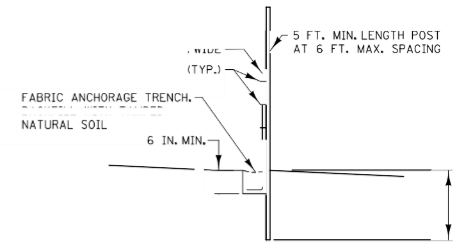

SILT FENCE TYPE PA @ (PREASSEMBLED)

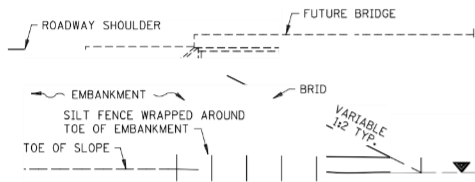

SILT FENCE ONLY

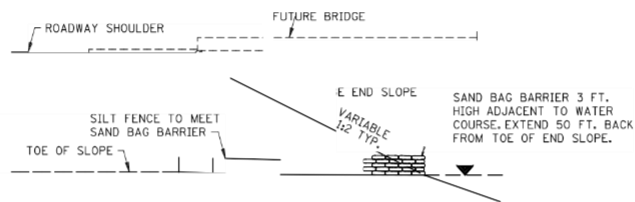

SILT FENCE WITH SAND BAG BARRIERS
INSTALLATION AT BRIDGE EMBANKMENT ADJACENT TO WATER

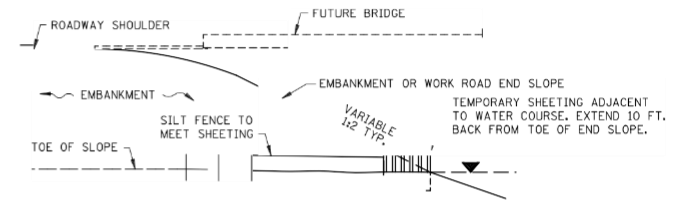

SILT FENCE WITH SHEETING

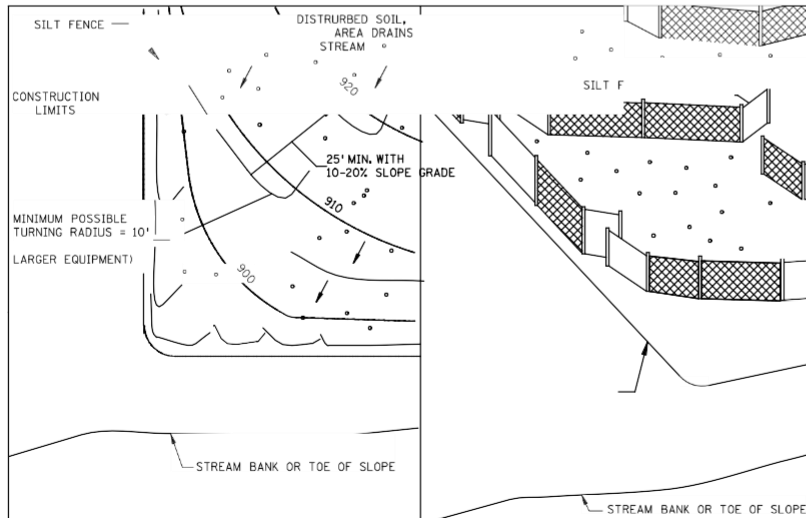

PLAN VIEW

PERSPECTIVE VIEW

3-HOOK INSTALLATION

REVISION: _____
 APPROVED: 2-28-2017
 [Signature]
 CHIEF ENVIRONMENTAL OFFICER

mn
 MINNESOTA
 DEPARTMENT
 OF
 TRANSPORTATION
 [Signature]
 STATE DESIGN ENGINEER

LOCATION AT TOE OF ROADWAY EMBANKMENT
 SEE SPECS. 2573, 3149 & 3886.

- NOTES:
- ④ WATER COURSE FLOW VELOCITY: STANDING. CONTRIBUTING SLOPE AREA: 1.2 ACRES.
 - ⑤ WATER COURSE FLOW VELOCITY: 1 TO 7 FT./SEC. CONTRIBUTING SLOPE AREA: 1 ACRE.
 - ⑥ WATER COURSE FLOW VELOCITY: 7 TO 10 FT./SEC. CONTRIBUTING SLOPE AREA: 3 ACRES.

TEMPORARY SEDIMENT CONTROL

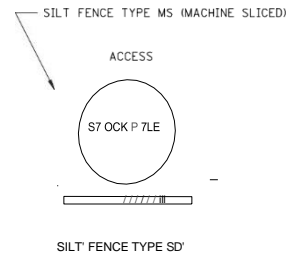
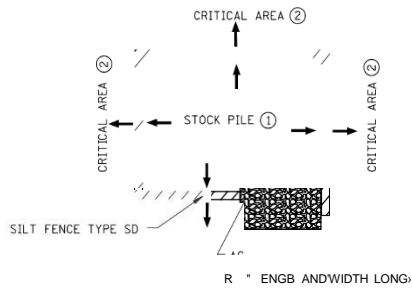
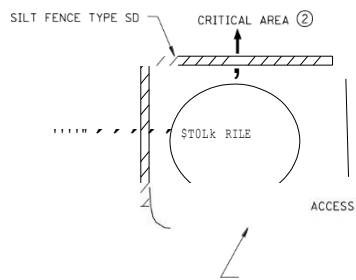

STOCK PILE SEDIMENT CONTROL

STOCK PILE CONTAINMENT

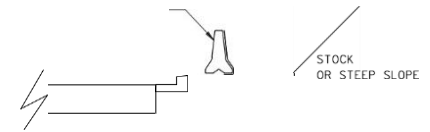
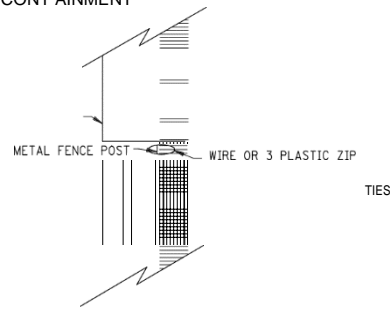
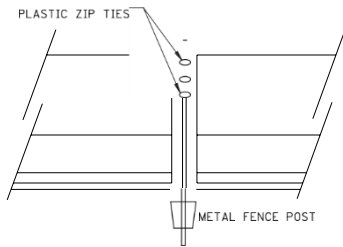

CURB AND GUTTER PROTECTION SYSTEM

SILT FENCE TYPE SD (SUPER DUTY) PROFILE VIEW WITHOUT LOOP BARS TOP VIEW

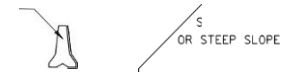
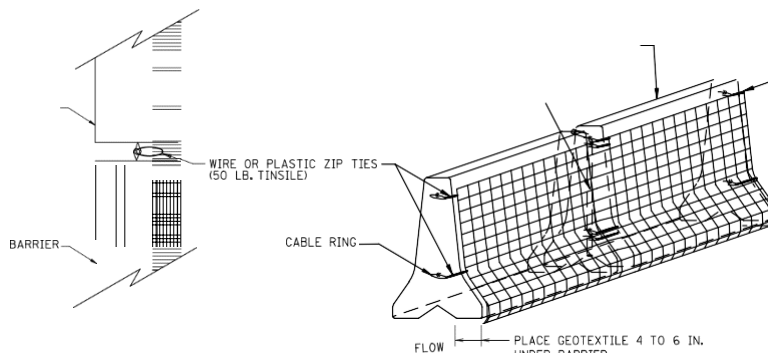

DITCH PROTECTION SYSTEM

SEE SPECS. 2533, 2573 & 3886.

SILT FENCE TYPE SD USED TO PROTECT CRITICAL AREAS FROM SHEET FLOW, AND AREAS WHERE OTHER

PLACE SILT FENCE TYPE SD ALONG A CONSTANT ELEVATION.

NOTES:

- ① PLACING STOCK PILES NEXT TO AN ENVIRONMENTALLY SENSITIVE AREA IS NOT RECOMMENDED. WHEN THERE ARE NO FEASIBLE ALTERNATIVES, PLACE SILT FENCE SD AS SHOWN OR AS DIRECTED BY THE ENGINEER.
- AREAS INCLUDE WETLANDS, JUDICIAL DITCHES, STREAMS, WATER BODIES, AND OTHER AREAS REQUIRING

APPROVED: 2-28-2017

 CHIEF ENVIRONMENTAL OFFICER

TOM SH... STATE DESIGN ENGINEER

SUPER DUTY SILT FENCE

TEMPORARY SEDIMENT CONTROL

SILT FENCE TYPE SD (SUPER DUTY) BARRIER WITH LOOP BARS

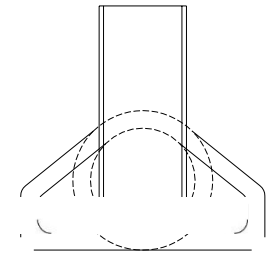
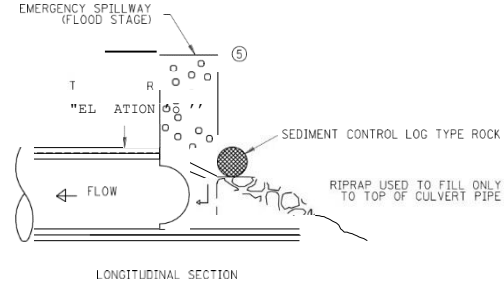
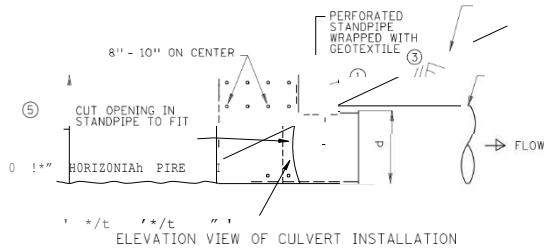
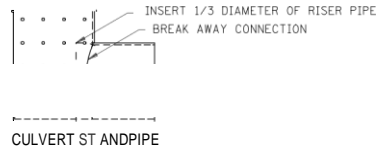
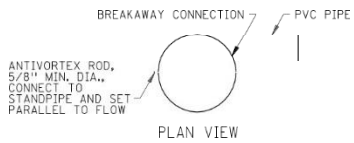

CULVERT STANDPIPE INSERT (D-RISER)

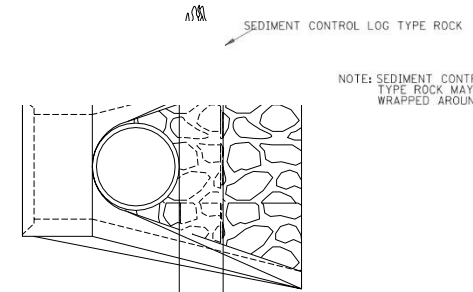

CULVERT STANDPIPE INSERT (D-RTSER)

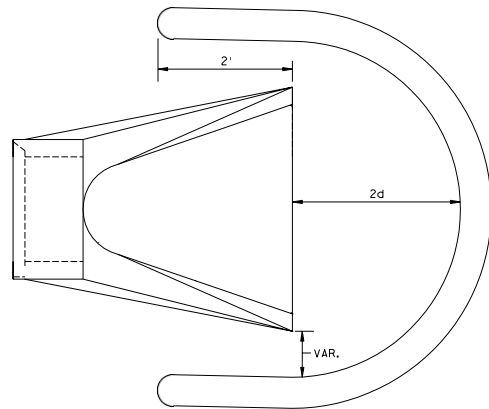

SEDIMENT CONTROL LOG WEIR (COMPOST, WOOD CHIP, OR ROCK)
d = CULVERT SIZE: 12" - 36"

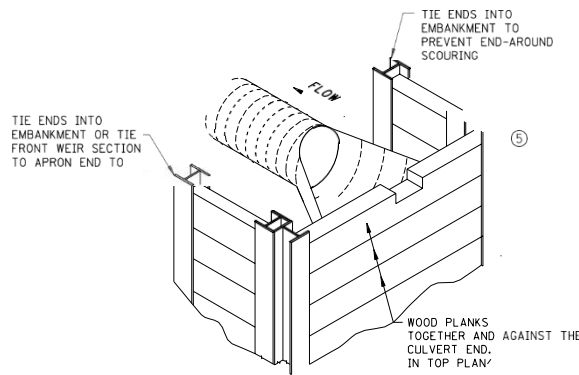

WOOD PLANK WEIR

NO TESTS:

SEE SPECS. 2573, 2891 & 3892.

① ROCK LOG OR SANDBAG TO HOLD STANDPIPE AND AS A SEAL BETWEEN RISER PIPE AND CULVERT.

ACT

MONOFILAMENT IN BOTH DIRECTIONS, MEETING SPEC. 3886

④ ROCK LOG OR RIP RAP TO HOLD STANDPIPE AND ACT AS A FILTER BETWEEN RISER PIPE AND CULVERT.

⑤ HEIGHT OVERFLOW NOT TO CAUSE FLOODING OF ROAD OR ADJACENT PROPERTIES.

REVISION: _____
 APPROVED: 2-28-2017
[Signature]
 CHIEF ENVIRONMENTAL OFFICER

mn
 MINNESOTA
 DEPARTMENT
 OF
 TRANSPORTATION
[Signature]
 STATE DESIGN ENGINEER

TEMPORARY SEDIMENT CONTROL

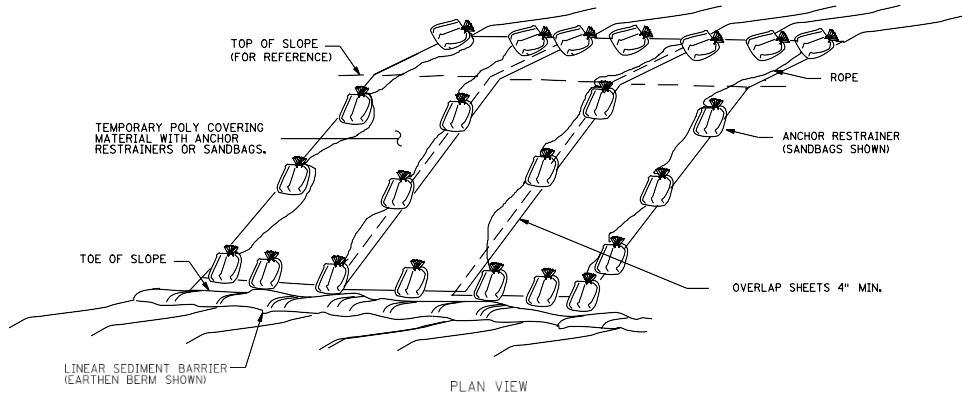

PLAN VIEW

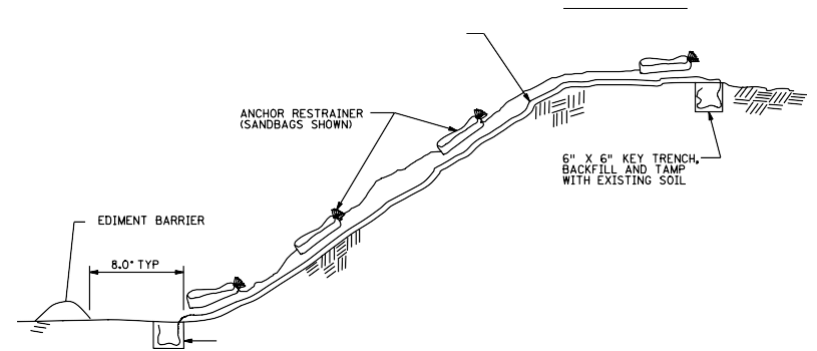

ELEVATION VIEW

TEMPORARY POLY COVER ON SLOPE

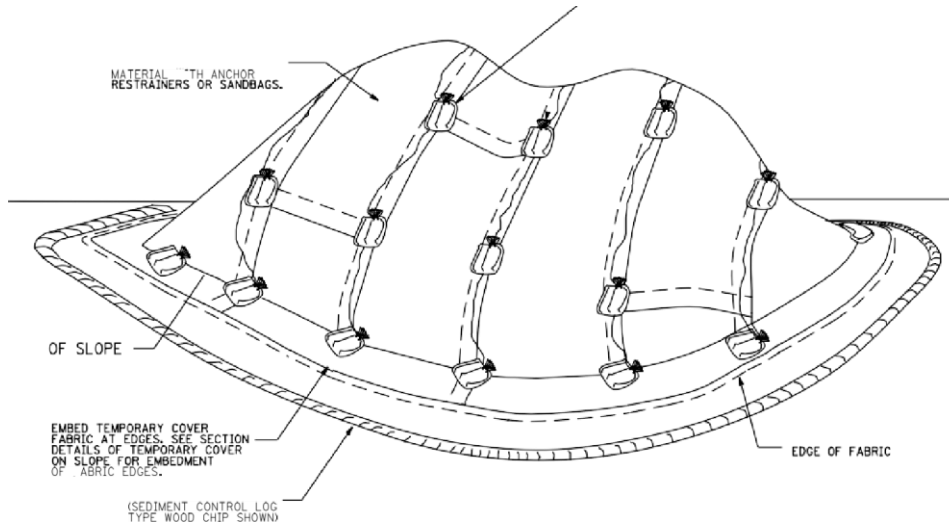

TEMPORARY POLY COVER ON STOCK PILE

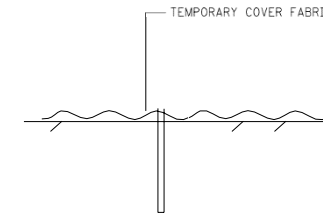

ANCHOR RESTRAINER (STEEL BAR AND WOODEN LATH OPTION)



STEEL REINFORCING BAR DETAIL

NOTES

ANCHOR RESTRAINERS: TYPE, QUANTITY, AND SPACING ARE INCIDENTAL TO POLY COVER. PROVIDE ON CORNERS AND SEAMS OF POLY COVER MATERIAL TO KEEP FROM BLOWING OFF. NO MINIMUM SPACING REQUIRED.

PERIMETER CONTROL: USE SEDIMENT CONTROL LOGS TYPE WOOD CHIP OR COMPOST, INCIDENTAL.

REVISION: _____

APPROVED: 2-28-2017

[Signature]
CHIEF ENVIRONMENTAL OFFICER

mn
MINNESOTA
DEPARTMENT OF TRANSPORTATION

[Signature]
STATE DESIGN ENGINEER

TEMPORARY EROSION CONTROL



CONSTRUCTION STORMWATER PERMIT (CSP)
(Not required for Category 1 Land Disturbance)

City of Alexandria
704 Broadway
Alexandria, MN 56308
(320) 763-6678 Telephone
(320) 763-3511 Fax

Permit Number: _____
Building Permit Number: _____
Date Issued: _____

Site Information

Project Address: _____ Owners Name: _____

Project Name: _____ Project Type: _____ Acres to be Disturbed: _____

Natural Resource Feature within 100 feet: Yes No Storm Drain within 100 feet: Yes No

If Yes, Identify Natural Resource Feature(s): _____

Proposed Start Date: _____ Proposed Completion Date: _____

Scope of Land Disturbance Activity:

- Category 2 Land Disturbance
- Category 3 Land Disturbance*
**Separate MPCA Construction Stormwater Permit Required*
- Part of Common Development Plan
- Site within 1 mile of Lake Winona

Best Management Practices

Areas not being actively worked to be stabilized within 14 days.
 ** (Areas within 1 mile of Lake Winona 7 days)
 Install/maintain perimeter controls and sediment barriers.
 Keep discharge points and receiving waters free of sediment.
 Protect natural resources (streams, wetlands, mature trees, etc).
 Properly protect storm drain inlets.
 Keep sediment from tracking onto street.
 Keep trash/litter collected and contained.
 Keep concrete washout areas clearly marked and maintained.
 Keep fueling, cleaning, maintenance areas free of leaks and spills.
 Keep potential stormwater contaminants inside or under cover.
 Make sure previously disturbed areas are/remain stabilized.
 Properly located and stabilize all stockpiles.
 Check site for compliance after each ½-inch (+) rain event.

Party Responsible for Installing, Implementing and Maintaining Erosion and Sediment Control per Plan

Name: _____

- Operator/General Contractor
- Owner (if Owner is Operator/General Contractor)

Contact Person: _____

Address: _____

City: _____ State: _____ Zip: _____

Telephone: _____ Cell: _____

Email: _____

GENERAL NOTES TO PERMITEE:

The costs associated with an on-site review by the City Engineer of reported stormwater management violations will be the responsibility of the property owner. Re-inspections of Non-Compliant Erosion and Sediment Control BMPs will be subject to re-inspection fees and may result in a "stop work" order being issued to the site.

CERTIFICATION STATEMENT

I certify under penalty of law that this document and all attachments, to the best of my knowledge and belief, true, accurate and complete. I am aware that there are significant penalties for submitting false information, including the possibility of fine and imprisonment for knowing violations.

Print Name and Title: _____

Signature of Permit Holder: _____ Date: _____

Approved By: _____ Date: _____