



Construction Stormwater Permit Application

**CITY OF ALEXANDRIA
Building Department 704 Broadway
Alexandria, MN 56308
(320) 763-6678 – Phone / (320) 763-3511 – Fax**

Land Disturbing Activities shall comply with the Minnesota Pollution Control Agency's Best Management Practices (BMPs).

The purpose of requiring this information as a part of the permit application process is to minimize both short-term and long-term erosion, contain sediment on site and manage post construction runoff.

The Following Land Disturbing Activities Require an *Erosion and Sediment Control Plan Sketch*.

- Category 1** - Construction activities disturbing less than ½ acre that include new construction, demolition, remodel/addition, accessorial structure and/or landscaping/retaining walls.

The Following Land Disturbing Activities Require a *Stormwater Management Plan*.

- Category 2** – Construction disturbing equal to or greater than ½ acre, but less than 1 acre; or construction on riparian lake lots (except attached decks and 2020 Minnesota Building Code, Section 1300.0120, Subp. 4. Work Exempt from Permit); or construction that is determined by the City Engineer to present a substantial risk to neighboring private properties, public infrastructure or waterways/wetlands.
- Category 3** – Construction activities disturbing equal to or greater than 1 acre. (Also requires separate MPCA Construction Stormwater Permit)

Category 1 Plan Submittal Requirements:

- **The Following Must be Included in or Attached to the *Erosion and Sediment Control Plan Sketch***
 - A clearly legible and complete Alexandria Construction Stormwater Permit application.
 - Location and type of perimeter erosion control.
 - Temporary construction site vehicle exit location and material that it will be constructed of.
 - Location and type of other erosion prevention and sediment control BMPs.
 - Location and type of storm drain inlet protection for all storm sewer inlets downstream of the site within one block or as directed by City Engineer.
 - Spot elevations (using an assumed datum) at:
 - Street edge at center of driveway or other appropriate benchmark
 - Existing ground within 10' radius of lot corners
 - Existing ground defining areas of steeper than 3:1 slopes
 - Plan elevations for structure (using an assumed datum) at:
 - Garage Floor, if applicable
 - Top of House Foundation, if applicable
 - Basement Floor, if applicable
 - Construction activity disturbance area
 - Standard illustrations (details) of proper installation of erosion prevention and sediment control BMPs. (MnDOT details provided for reference, pages 7-15)
- **The Following Notes Must be Placed on Plan Sketch and Adhered to as Applicable:**
 - The street shall be swept clean before the end of each day of active construction, when sediment is tracked onto the street.
 - Areas with slopes greater than 3:1 and areas adjacent to wetlands/waterbodies disturbed during construction shall be protected with temporary vegetation, mulching or other means as soon as practical.
 - All exposed soil areas shall be stabilized as soon as practical.
 - Unworked soils that remain exposed and not in use for longer than 14-days shall be seeded with temporary seed (grass, oats or wheat) in addition to being stabilized.
 - No concrete washout shall occur on site unless it is done with an approved MPCA device or standard.
 - Stockpiles shall be stabilized and surrounded with adequate perimeter control to prevent sedimentation.
 - Inlet protection for all storm sewer inlets downstream and within one block of the site shall be installed and maintained.
 - Site shall be kept clean at all times and refuse properly controlled.
 - Temporary pumping shall not be permitted without use of an approved MPCA device or standard.
 - Soil compaction shall be minimized.
 - All temporary synthetic BMPs to be removed upon permanent stabilization.

Category 1 Erosion and Sediment Control Plan Sketch

(This page is **not** required for Category 2 or Category 3)

Please Show:

- Location and type of perimeter control
- Location and type of construction exit
- Location and type of other erosion prevention and sediment control BMPs
- Location and type of inlet protection for all storm sewer inlets within 1 block downstream
- Name, telephone number and email address of individual responsible for the site and maintenance of the erosion and sediment controls.
- Spot elevations (see list on page 3)
- Standard illustrations (details) of proper instillation of erosion prevention and sediment control BMPs

- The street shall be swept clean before the end of each day of active construction, when sediment is tracked onto the street.
- Areas with slopes greater than 3:1 and areas adjacent to wetlands/waterbodies disturbed during construction shall be protected with temporary vegetation, mulching or other means as soon as practical.
- All exposed soil areas shall be stabilized as soon as practical.
- Unworked soils that remain exposed and not in use for longer than 14-days shall be seeded with temporary seed (grass, oats or wheat) in addition to being stabilized.
- No concrete washout shall occur on site unless it is done with an approved MPCA device or standard.
- Stockpiles shall be stabilized and surrounded with adequate perimeter control to prevent sedimentation.
- Inlet protection for all storm sewer inlets downstream and within one block of the site shall be installed and maintained.
- Site shall be kept clean at all times and refuse properly controlled.
- Temporary pumping shall not be permitted without use of an approved MPCA device or standard.
- Soil compaction shall be minimized.
- All temporary synthetic BMPs to be removed upon permanent stabilization.

□ **Category 2 Plan Submittal Requirements:**

- **The Following Must be Included in or Attached to the *Stormwater Management Plan***
- A clearly legible and complete Alexandria Construction Stormwater Permit application.
- Drawings prepared to an easily legible scale, shall be clearly labeled with a north arrow and a date of preparation.
- Names, addresses and phone numbers of the land surveyor, and engineer, if any.
- Project description including property boundaries, areas to be disturbed, and the nature and purpose of the land disturbing activity and the amount of grading involved.
- Spot elevations of proposed grades in relation to existing grades on the subject property and adjacent properties.
- Existing site conditions including topography, vegetation and drainage arrows.
- Areas where finished slope will be steeper than 3:1.
- Critical erosion areas including areas on the site that have potential for erosion problems.
- Erosion and sediment control devices including methods to be used to control erosion on the site, both during and after the construction activity process.
- Location of and type of storm drain inlet protection for all storm sewer inlets downstream of the site within one block or as directed by City Engineer, wetlands, wet sediment basins and lakes.
- Location of material stockpiles.
- Plan for temporary site stabilization.
- Permanent stabilization including how the site will be stabilized after construction is completed, including specifications.
- Temporary construction site vehicle exit location and material that it will be constructed of.
- Adjacent areas including neighboring streams, roads, residential areas, etc. which might be affected by the land disturbing activity.
- Project schedule including a projected timeframe for completion of all site activities.
- Phasing of construction including the nature and purpose of the land disturbing activity, utilities, and building construction.
- Provisions for the removal of temporary synthetic erosion prevention and sediment control BMPs upon establishment of permanent vegetation.
- Surveyed Elevations (using North American Vertical Datum of 1988) at:
 - Benchmark
 - Street edge at center of driveway
 - Existing ground within 10' radius of lot corners
 - Existing ground defining areas of steeper than 3:1 slopes
- Plan elevations for structure (using North American Vertical Datum of 1988) at:
 - Garage Floor, if applicable
 - Top of House Foundation, if applicable
 - Basement Floor, if applicable
 - Construction activity disturbance area
- Standard illustrations (details) of proper installation of erosion prevention and sediment control BMPs (MnDOT details provided for reference, pages 11-19).

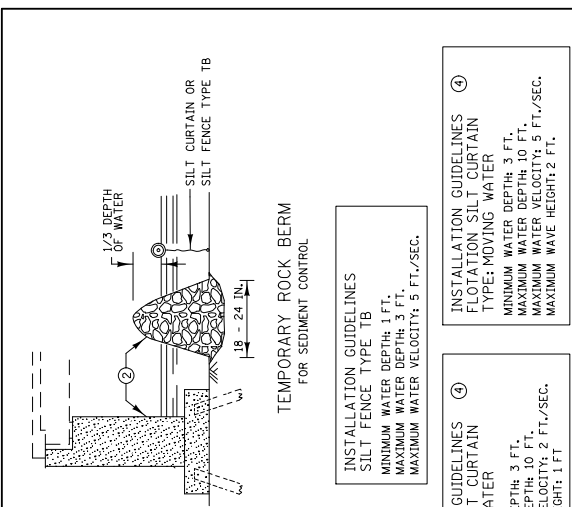

TEMPORARY ROCK BERM FOR SEDIMENT CONTROL

INSTALLATION GUIDELINES
SILT FENCE TYPE TB
MINIMUM WATER DEPTH: 1 FT.
MAXIMUM WATER DEPTH: 3 FT.
MAXIMUM WATER VELOCITY: 5 FT./SEC.

INSTALLATION GUIDELINES
FLOTATION SILT CURTAIN
TYPE: STILL WATER
MINIMUM WATER DEPTH: 3 FT.
MAXIMUM WATER DEPTH: 10 FT.
MAXIMUM WATER VELOCITY: 2 FT./SEC.
MAXIMUM WAVE HEIGHT: 1 FT.

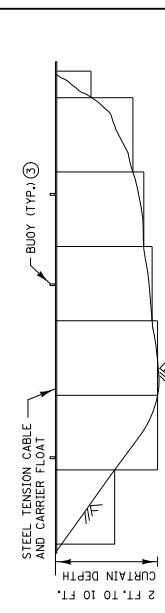

FRONT VIEW FOR FLOTATION SILT CURTAIN

NOTES:

- SEE SPECS. 2573, 3886, 3887 & 3893.
- FOR ANCHOR SPACING AND WEIGHT REQUIREMENTS, SEE SPEC. 2573.
- IN AREAS WHERE THE PLAN CALLS FOR RIPRAP AT A BRIDGE, CULVERT, OR SLOPE, A TEMPORARY ROCK BERM CONSTRUCTED FROM THE RIPRAP CAN BE USED TO PROVIDE ADDITIONAL PROTECTION. WHEN THE WORK IS COMPLETE THE RIPRAP CAN THEN BE MOVED TO THE PERMANENT LOCATION INDICATED IN THE PLANS. THE TEMPORARY ROCK BERM IS INCIDENTAL.
- ON U.S. COAST GUARD OR OTHER MOTORIZED WATERWAYS, BUOYS ARE REQUIRED TO MARK THE ENDS AND SPECIAL AREAS FOR VISIBILITY. PLACE BUOYS AS REQUIRED FOR NAVIGATIONAL PURPOSES.
- MINIMUM WATER DEPTH APPLIES TO THE DEEPEST POINT ALONG THE FLOTATION SILT CURTAIN OR SILT FENCE TYPE TB FOR DETERMINING APPLICABILITY OF FLOTATION SILT CURTAIN OR SILT FENCE TYPE TB.
- SILT CURTAIN SHOULD BE REMOVED WHEN THE AREA CONTRIBUTING DIRECT RUNOFF HAS BEEN TEMPORARILY STABILIZED. SILT CURTAIN SHOULD ALSO BE REMOVED BEFORE WINTER IF ICE UP OR ICE FLOW IS ANTICIPATED.
- EMBED POST INTO BOTTOM A MINIMUM OF 40% OF THE WATER DEPTH (INCLUDING WAVE HEIGHT), BUT IN NO CASE SHALL EMBEDMENT BE LESS THAN 2 FEET.
- ANCHOR FLOAT MUST BE CONNECTED SECURELY TO SLEEVE WITH A MINIMUM TENSILE STRENGTH OF 100 LBS. CONNECTION METHOD MUST ALLOW FOR SLEEVE TO MOVE FREELY ON POST.
- PROVIDE SUFFICIENT NUMBER OF POST ANCHORS TO MAINTAIN SILT CURTAIN POSITION.

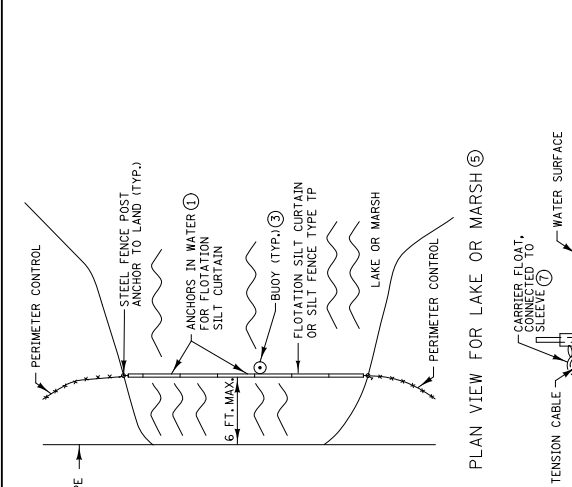

PLAN VIEW FOR LAKE OR MARSH

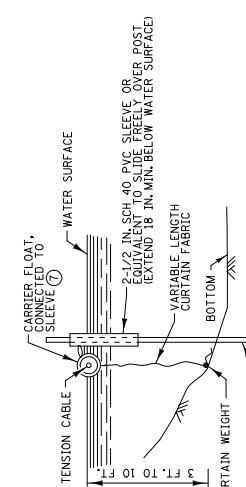

ALTERNATE FLOTATION SILT CURTAIN

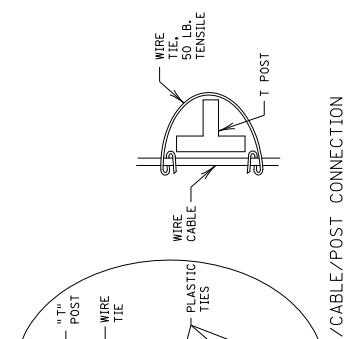

FABRIC/CABLE/POST CONNECTION

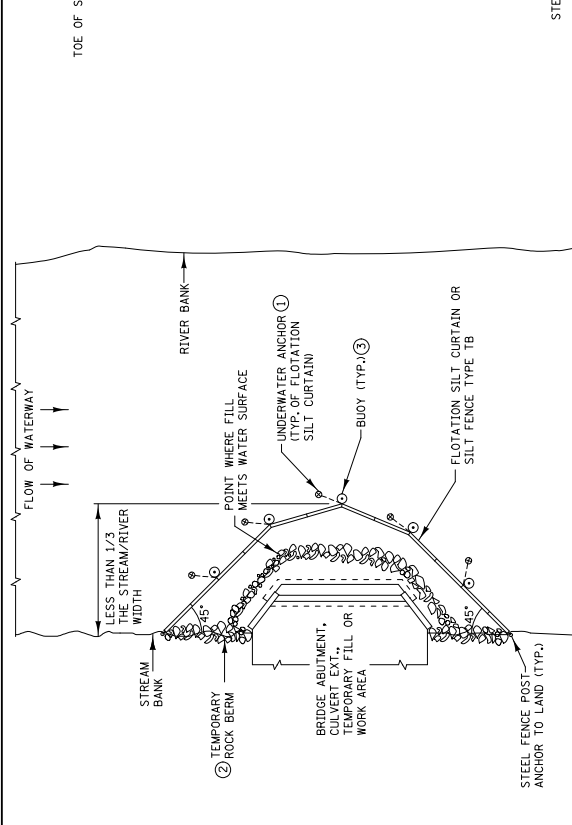

PLAN VIEW FOR STREAM

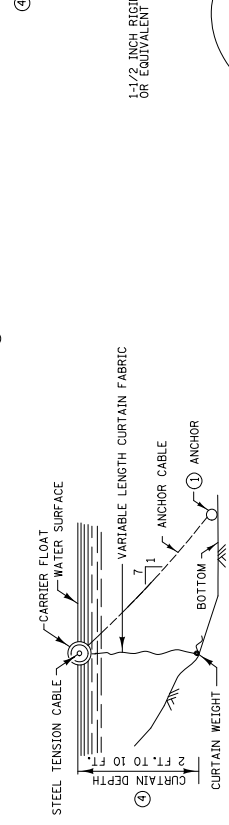

FLOTATION SILT CURTAIN

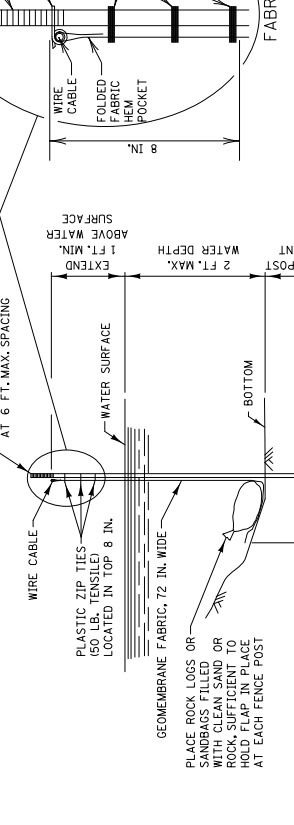

SILT FENCE TYPE TB

	REVISION: 2-28-2017 APPROVED: <i>[Signature]</i> CHIEF ENVIRONMENTAL OFFICER	REVISION: <i>[Signature]</i> APPROVED: <i>[Signature]</i> STATE DESIGN ENGINEER
	TEMPORARY SEDIMENT CONTROL SILT CURTAIN OR SILT FENCE TYPE TB	STANDARD PLAN 5-297.405

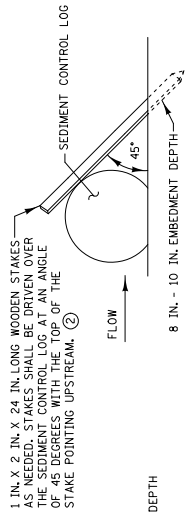
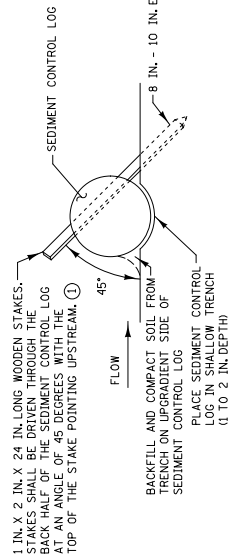

SEDIMENT CONTROL LOGS

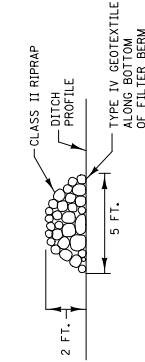
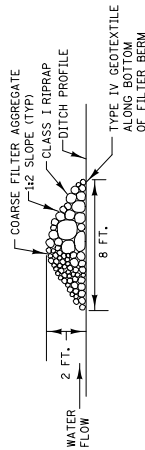

FILTER BERMS

TYPE 1 (COMPOST), TYPE 2 (SLASH MULCH), OR TYPE 4 (TOPSOIL)

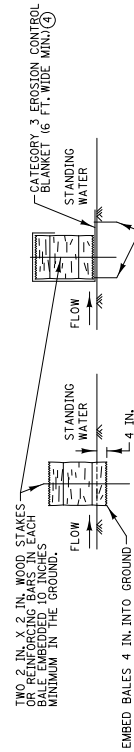
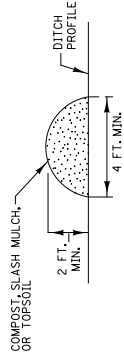

BALE BARRIERS ③

NOTES:

- SEE SPECS. 2573, 3149, 3874, 3882, 3886, & 3897.
- ① SPACE BETWEEN STAKES SHALL BE A MAXIMUM OF 1 FOOT FOR DITCH CHECKS OR 2 FEET FOR OTHER APPLICATIONS.
- ② PLACE STAKES AS NEEDED TO PREVENT MOVEMENT OF SEDIMENT CONTROL LOGS PLACED ON SLOPES OR AS NEEDED DUE TO OTHER FACTORS. STAKES SHALL BE INCIDENTAL.
- ③ TO BE USED FOR CRITICAL PERIMETER CONTROL AREAS WHERE STANDING WATER OCCURS (6 INCH MAX. DEPTH). BALES SHALL CONSIST OF TYPE 1 MULCH OF APPROXIMATELY 14 IN. X 18 IN. X 36 IN. LONG. BALES SHALL BE PLACED ON EDGE AND BUTTED TIGHT TO ADJACENT BALES.
- ④ INSTEAD OF TRENCHING, PLACE BALE ON THE BLANKET AND WRAP BLANKET AROUND THE BALE. PLACE STAKE THROUGH BALE AND BLANKET.

REVISION: 2-28-2017

APPROVED: *[Signature]*

CHIEF ENVIRONMENTAL OFFICER

REVISED: *[Signature]*

APPROVED: *[Signature]*

STATE DESIGN ENGINEER

2-28-2017

TEMPORARY SEDIMENT CONTROL

FILTER BERMS, SEDIMENT CONTROL LOGS, AND BALE BARRIERS

STANDARD PLAN 5-297.405

2 OF 8

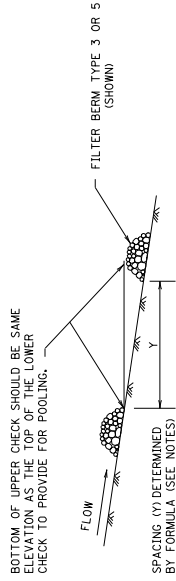

DITCH CHECK SPACING
(FOR ALL FILTER BERM TYPES)

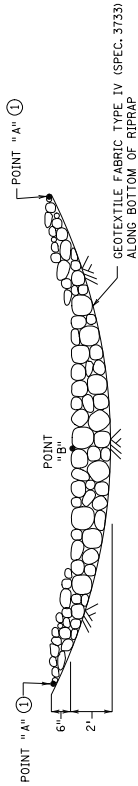

ROCK DITCH CHECKS
FILTER BERMS TYPE 3 (ROCK WEEPER) OR FILTER TYPE 5 (ROCK) ②③
(FOR USE ON ROUGH GRADED AREAS)

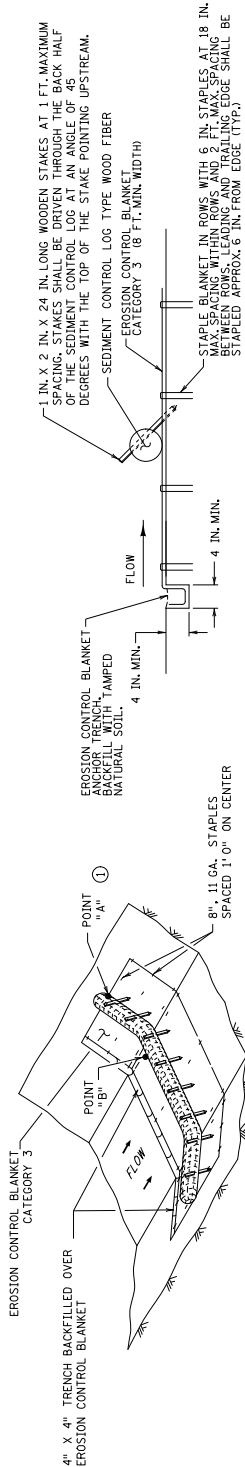

SEDIMENT CONTROL LOG TYPE BLANKET SYSTEM ④

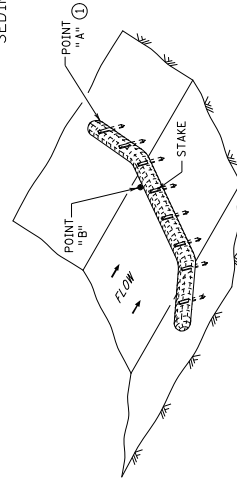

SEDIMENT CONTROL LOG TYPE WOOD FIBER, OR TYPE COMPOST ⑤
(FOR USE ON ROUGH GRADED AREAS)

- NOTES:
SEE SPECS. 2573, 3601, 3733, 3885, 3886 & 3889.
FOR DITCH CHECKS, PLACE SEDIMENT CONTROL LOG PERPENDICULAR TO FLOW AND IN A CRESCENT SHAPE WITH THE ENDS FACING UPSTREAM.
APPROXIMATE SPACING BETWEEN EACH DITCH CHECK SHOULD BE DETERMINED FROM THE FOLLOWING SPACING FORMULA:
APPROXIMATE SPACING OF DITCH CHECKS (FT.) = $Y = \frac{Z}{100} \times 100$
① POINT "A" MUST BE A MINIMUM OF 6 INCHES HIGHER THAN POINT "B" TO ENSURE THAT WATER FLOWS OVER THE DIKE AND NOT AROUND THE ENDS.
② PERMANENT ROCK DITCH CHECKS PLACED WITHIN THE CLEAR ZONE ARE TO BE 18" OR LESS IN HEIGHT. A 1:6 APPROACH AND DEPARTURE SLOPE SHALL BE PROVIDED.
③ DITCH GRADE 3% - 5%. MAX. FLOW VELOCITY 12 FT./SEC.
④ DITCH GRADE 1.5% - 3%. MAX. FLOW VELOCITY 4.5 FT./SEC.
⑤ DITCH GRADE 1.5% - 3%. MAX. FLOW VELOCITY 1.5 FT./SEC.

	 STATE DESIGN ENGINEER	REVISIONS: APPROVED: 2-28-2017 ... ENVIRONMENTAL OFFICE	TEMPORARY SEDIMENT CONTROL DITCH CHECK
	2-28-2017	STANDARD PLAN 5-297.405	3 OF 8

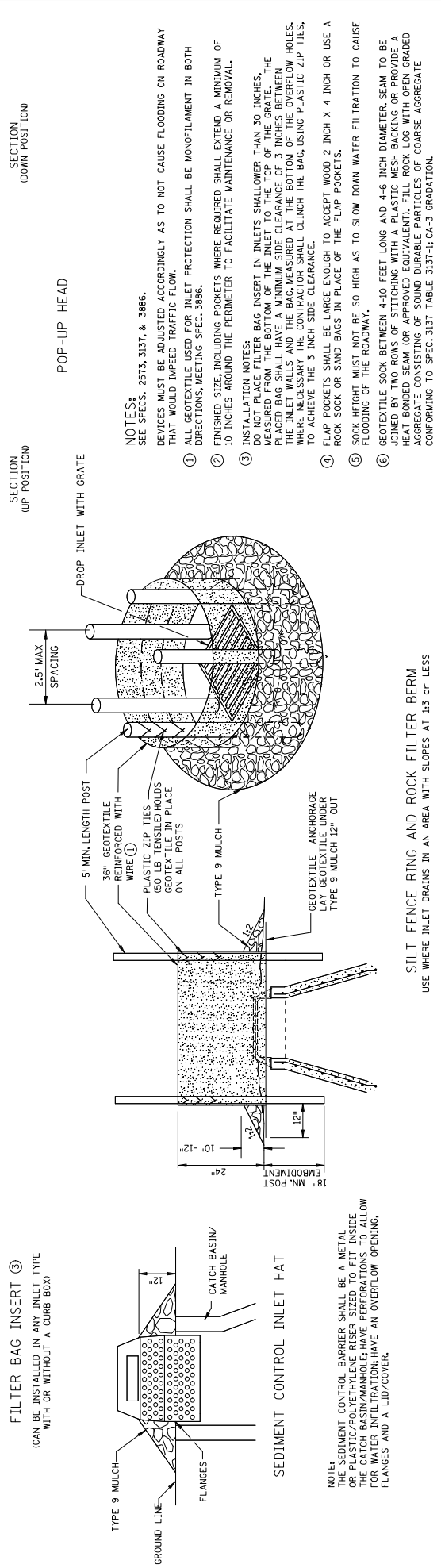
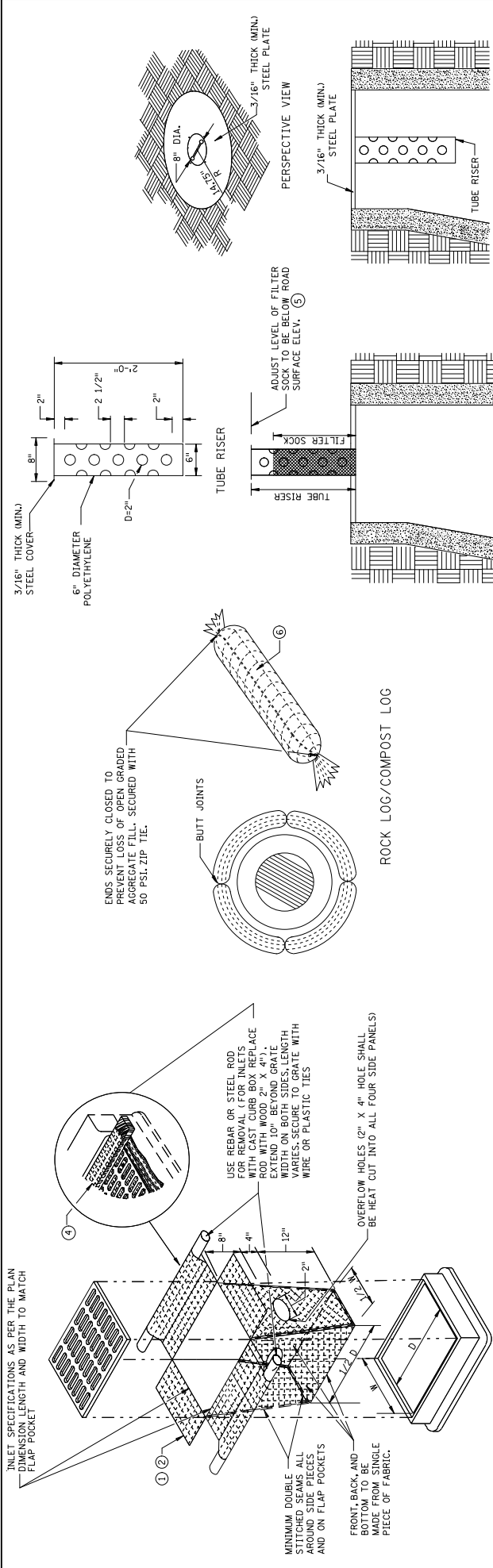

- NOTES:
SEE SPECS. 2573, 3137, & 3886.
DEVICES MUST BE ADJUSTED ACCORDINGLY AS TO NOT CAUSE FLOODING ON ROADWAY THAT WOULD IMPED TRAFFIC FLOW.
- 1 ALL GEOTEXTILE USED FOR INLET PROTECTION SHALL BE MONOFILAMENT IN BOTH DIRECTIONS, MEETING SPEC. 3886.
 - 2 FINISHED SIZE INCLUDING POCKETS WHERE REQUIRED, SHALL EXTEND A MINIMUM OF 10 INCHES AROUND THE PERIMETER TO FACILITATE MAINTENANCE OR REMOVAL.
 - 3 INSTALLATION NOTES:
DO NOT PLACE FILTER BAG INSERT IN INLETS SHALLOWER THAN 30 INCHES. DO NOT PLACE FILTER BAG INSERT IN INLETS WITH OVERFLOW HOLES. THE PLACED BAG SHALL HAVE A MINIMUM SIDE CLEARANCE OF 3 INCHES BETWEEN THE INLET WALLS AND THE BAG, MEASURED AT THE BOTTOM OF THE OVERFLOW HOLES, WHERE NECESSARY THE CONTRACTOR SHALL CLINCH THE BAG USING PLASTIC ZIP TIES, TO ACHIEVE THE 3 INCH SIDE CLEARANCE.
 - 4 FLAP POCKETS SHALL BE LARGE ENOUGH TO ACCEPT WOOD 2 INCH X 4 INCH OR USE A ROCK SOCK OR SAND BAGS IN PLACE OF THE FLAP POCKETS.
 - 5 SOCK HEIGHT MUST NOT BE 50 HIGH AS TO SLOW DOWN WATER FILTRATION TO CAUSE FLOODING OF THE ROADWAY.
 - 6 GEOTEXTILE SOCK BETWEEN 4-10 FEET LONG AND 4-6 INCH DIAMETER SEAM TO BE JOINED BY TWO ROWS OF STITCHING WITH A PLASTIC MESH BACKING OR PROVIDE A HEAT BONDED SEAM OR APPROVED EQUIVALENT. FILL ROCK LOG WITH OPEN GRADED AGGREGATE CONSISTING OF SOUND DURABLE PARTICLES OF COARSE AGGREGATE CONFORMING TO SPEC. 3137 TABLE 3137-11-CA-3 GRADATION.

REVISION:	TEMPORARY SEDIMENT CONTROL
APPROVED: 2-28-2017	STORM DRAIN INLET PROTECTION
DESIGNED BY: [Signature]	STANDARD PLAN 5-297.405
STATE DESIGN ENGINEER	4 OF 8
MINNESOTA DEPARTMENT OF TRANSPORTATION	2-28-2017
REVISOR: [Signature]	TEMPORARY SEDIMENT CONTROL
APPROVED: [Signature]	STORM DRAIN INLET PROTECTION
STATE DESIGN ENGINEER	STANDARD PLAN 5-297.405
MINNESOTA DEPARTMENT OF TRANSPORTATION	4 OF 8

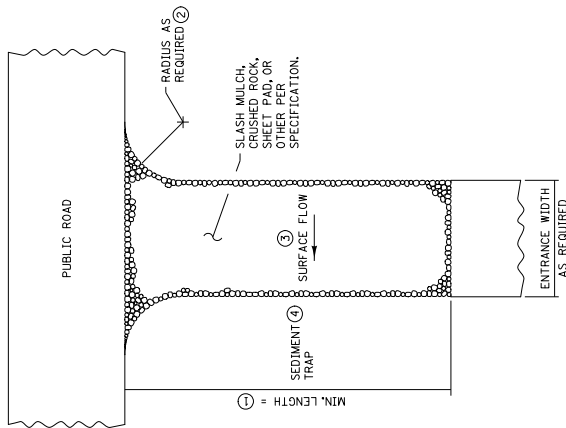

SLASH MULCH, CRUSHED ROCK, OR SHEET PAD CONSTRUCTION EXIT ⑤①

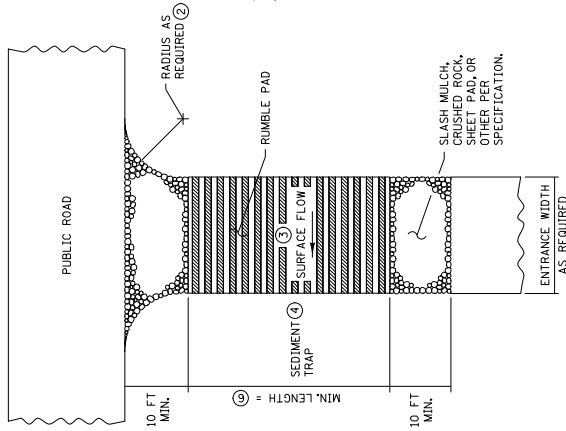

RUMBLE PAD CONSTRUCTION EXIT ⑤⑦

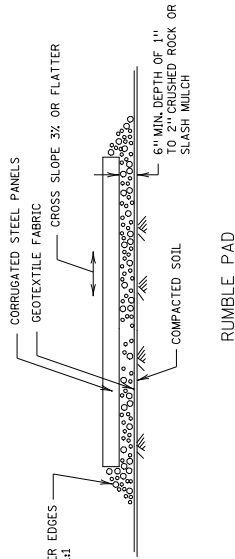

RUMBLE PAD

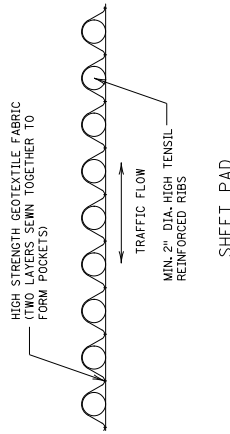

SHEET PAD

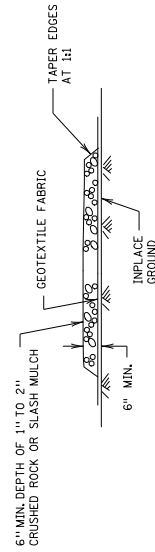

SLASH MULCH OR CRUSHED ROCK

NOTES:

SEE SPECS. 2573 & 3882.

- ① MINIMUM LENGTH SHALL BE THE GREATER OF 50 FEET OR A LENGTH SUFFICIENT TO ALLOW A MINIMUM OF 5 TIRE ROTATIONS ON THE PROVIDED PAD. MINIMUM LENGTH SHALL BE CALCULATED USING THE LARGEST TIRE WHICH WILL BE USED IN TYPICAL OPERATIONS.
- ② PROVIDE RADIUS OR WIDEN PAD SUFFICIENTLY TO PREVENT VEHICLE TIRES FROM TRACKING OFF OF PAD WHEN LEAVING SITE.
- ③ IF RUNOFF FROM DISTURBED AREAS FLOWS TOWARD CONSTRUCTION EXITS, PREVENT RUNOFF FROM DRAINING DIRECTLY TO PUBLIC ROAD OVER CONSTRUCTION EXIT BY PROVIDING A SEDIMENT TRAP WITH SUFFICIENT OVERFLOW CAPACITY. PROVIDING INSUFFICIENT PROVIDE OTHER MEANS OF INTERCEPTING RUNOFF.
- ④ IF RUNOFF FROM CONSTRUCTION EXITS WILL DRAIN OFF OF PROJECT SITE, PROVIDE SEDIMENT TRAP WITH STABILIZED OVERFLOW.
- ⑤ IF A TIRE WASH OFF IS REQUIRED, THE CONSTRUCTION EXITS SHALL BE GRADED TO DRAIN THE WASH WATER TO A SEDIMENT TRAP.
- ⑥ MINIMUM LENGTH OF RUMBLE PAD SHALL BE 20 FEET, OR AS REQUIRED TO REMOVE SEDIMENT FROM TIRES. IF SIGNIFICANT SEDIMENT IS TRACKED FROM THE SITE, THE RUMBLE PAD SHALL BE LENGTHENED OR THE DESIGN MODIFIED TO PROVIDE ADDITIONAL VIBRATION, WASH-OFF LENGTH SHALL BE AS REQUIRED TO EFFECTIVELY REMOVE CONSTRUCTION SEDIMENT FROM VEHICLE TIRES.
- ⑦ MAINTENANCE OF CONSTRUCTION EXITS SHALL OCCUR WHEN THE EFFECTIVENESS OF SEDIMENT REMOVAL HAS BEEN REDUCED. MAINTENANCE SHALL CONSIST OF REMOVING SEDIMENT FROM CONSTRUCTION EXITS, REPAIRING OR REPLACING GEOTEXTILE, SLASH MULCH OR CRUSHED ROCK OVER SEDIMENT FILLED MATERIAL TO RESTORE EFFECTIVENESS.

REVISED:

APPROVED: *Tom J. ...*
STATE DESIGN ENGINEER



REVISION:

APPROVED: 2-28-2017
... CHIEF ENVIRONMENTAL OFFICER

TEMPORARY SEDIMENT CONTROL
STABILIZED CONSTRUCTION EXIT

STANDARD PLAN 5-297.405

2-28-2017

5 OF 8

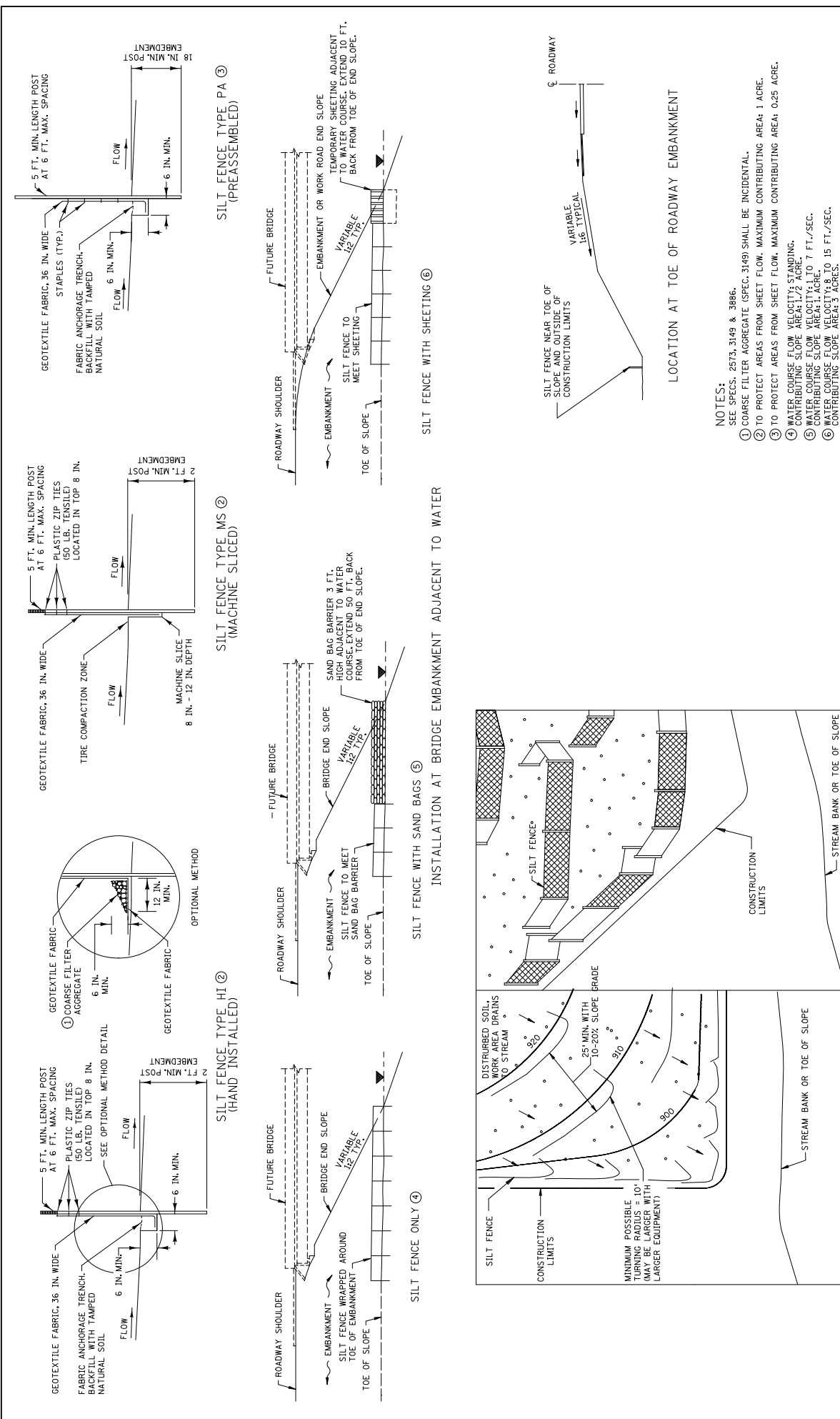

- NOTES:
- SEE SPECS. 2573.3149 & 3886.
 - ① COARSE FILTER AGGREGATE (SPEC. 3149) SHALL BE INCIDENTAL.
 - ② TO PROTECT AREAS FROM SHEET FLOW. MAXIMUM CONTRIBUTING AREA: 1 ACRE.
 - ③ TO PROTECT AREAS FROM SHEET FLOW. MAXIMUM CONTRIBUTING AREA: 0.25 ACRE.
 - ④ WATER COURSE FLOW VELOCITY: STANDING.
 - ⑤ WATER COURSE FLOW VELOCITY: 1 TO 7 FT./SEC. CONTRIBUTING SLOPE AREA: 1 ACRE.
 - ⑥ WATER COURSE FLOW VELOCITY: 8 TO 15 FT./SEC. CONTRIBUTING SLOPE AREA: 3 ACRES.

REVISION:	APPROVED:	REVISION:	APPROVED:
APPROVED: 2-28-2017	<i>[Signature]</i>	TEMPORARY SEDIMENT CONTROL	SILT FENCE
CHIEF ENVIRONMENTAL OFFICER	STATE DESIGN ENGINEER	STANDARD PLAN 5-297.405	6 OF 8

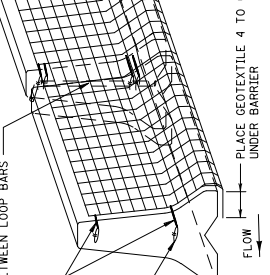
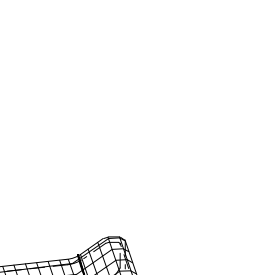
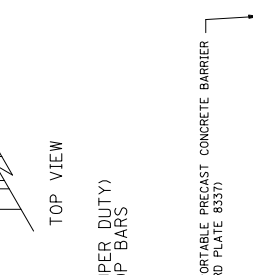
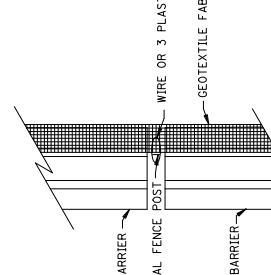
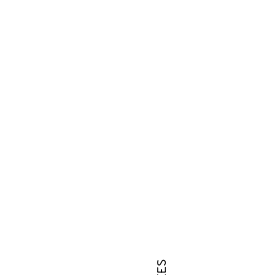
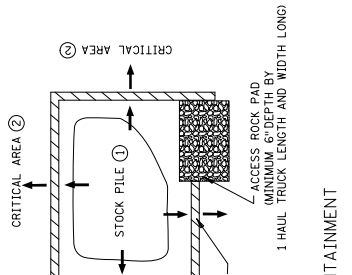
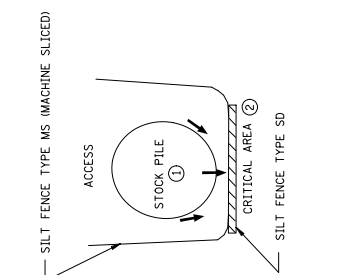
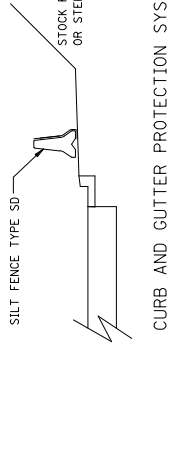
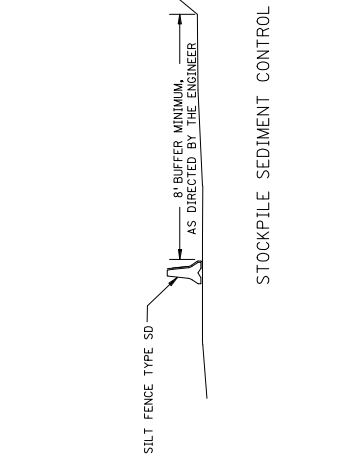

NOTES:
 SEE SPECS. 2533, 2573 & 3886.
 SILT FENCE TYPE SD USED TO PROTECT CRITICAL AREAS FROM SHEET FLOW, AND AREAS WHERE OTHER SILT FENCES CANNOT BE PLACED. MAXIMUM CONTRIBUTING AREA, 1 ACRE.
 PLACE SILT FENCE TYPE SD ALONG A CONSTANT ELEVATION.
 SILT FENCE TYPE SD CAN UTILIZE EITHER A CONCRETE, OR WATER FILLED, TEMPORARY MEDIAN BARRIER.
 ① PLACING STOCK PILES NEXT TO AN ENVIRONMENTALLY SENSITIVE AREA IS NOT RECOMMENDED, WHEN THERE ARE NO FEASIBLE ALTERNATIVES, PLACE SILT FENCE SD AS SHOWN OR AS DIRECTED BY THE ENGINEER.
 ② CRITICAL AREAS INCLUDE WETLANDS, JUDICIAL DITCHES, STREAMS, WATER BODIES, AND OTHER AREAS REQUIRING PROTECTION.

REVISION: 2-28-2017
 APPROVED: [Signature]
 STATE DESIGN ENGINEER

TEMPORARY SEDIMENT CONTROL
 SUPER DUTY SILT FENCE
 STANDARD PLAN 5-297.405 7 OF 8

REVISION: 2-28-2017
 APPROVED: [Signature]
 CHIEF ENVIRONMENTAL OFFICER

MINNESOTA DEPARTMENT OF TRANSPORTATION

SILT FENCE TYPE SD (SUPER DUTY) BARRIER WITH LOOP BARS

TOP VIEW
 PERSPECTIVE VIEW
 FLOW

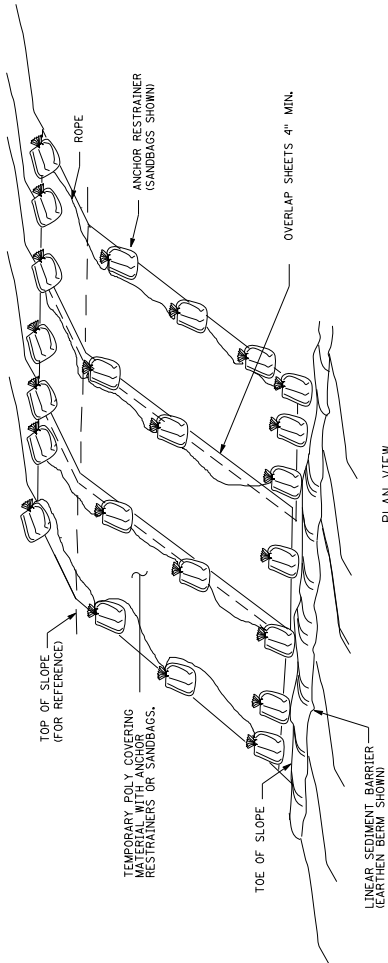

PLAN VIEW

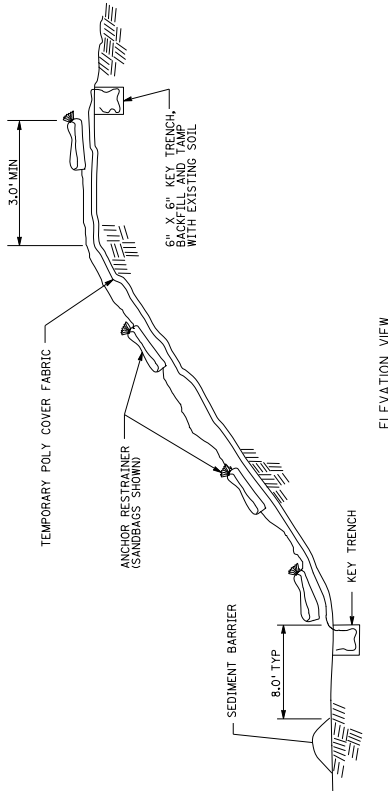

ELEVATION VIEW

TEMPORARY POLY COVER ON SLOPE

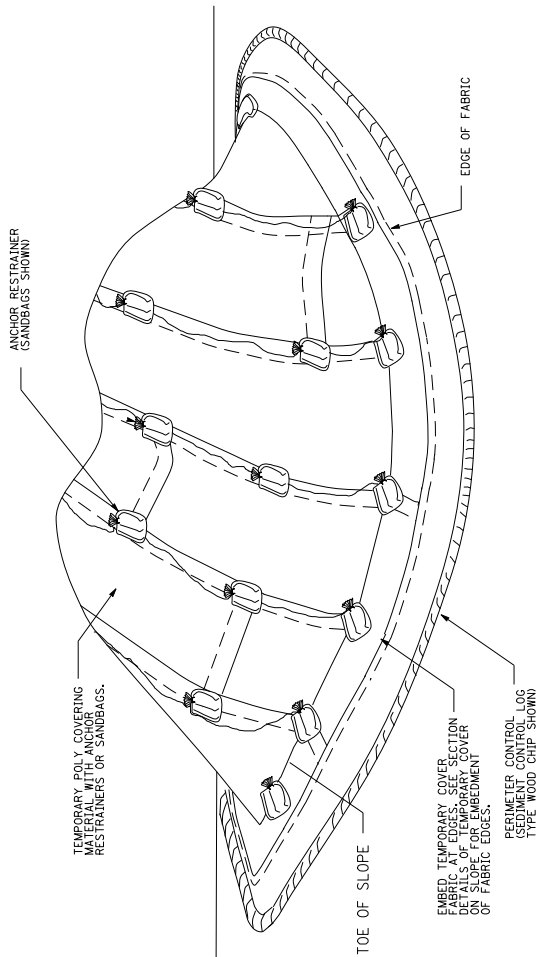

TEMPORARY POLY COVER ON STOCKPILE

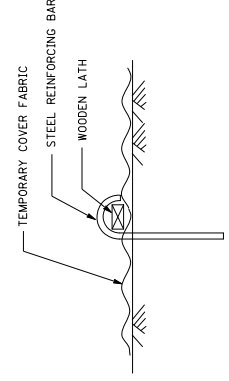

ANCHOR RESTRAINER (STEEL BAR AND WOODEN LATH OPTION)

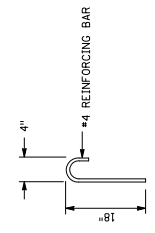

STEEL REINFORCING BAR DETAIL

NOTES
 ANCHOR RESTRAINERS: TYPE, QUANTITY, AND SPACING ARE INCIDENTAL TO POLY COVER. PROVIDE ON CORNERS AND SEAMS OF POLY COVER MATERIAL TO KEEP FROM BLOWING OFF. NO MINIMUM SPACING REQUIRED.
 PERIMETER CONTROL: USE SEDIMENT CONTROL LOGS TYPE WOOD CHIP OR COMPOST, INCIDENTAL.

	REVISIONS: APPROVED: <i>[Signature]</i> 2-28-2017 STATE DESIGN ENGINEER	TEMPORARY EROSION CONTROL TEMPORARY POLY COVERINGS
	STANDARD PLAN 5-297.409	1 OF 1

☐ **Category 3 Plan Submittal Requirements:**

- The **Following Must be Included in or Attached to the *Stormwater Management Plan***
- A clearly legible and complete Alexandria Construction Stormwater Permit application.
- MPCA Construction Stormwater General Permit MNR100001 Section 5 content.
- Identification and description including:
 1. Project name.
 2. Project type (residential, commercial, industrial, road construction, or other).
 3. Project location.
 4. Parcel identification number (legal description).
 5. Copies of permits or permit applications required by any other governmental entity or agencies including mitigation measures required as a result of any review for the project.
- Existing Conditions - A complete site plan and specifications, signed by a person who is certified to design the plan shall be drawn to an easily legible scale, shall be clearly labeled with a north arrow and a date of preparation, and shall include, at a minimum, the following information:
 1. Property lines and lot dimensions.
 2. Existing zoning classifications for land within and abutting the development, including shoreland, floodway, flood fringe, or general floodplain, and other natural resource overlay districts.
 3. Show ordinary high water marks of all navigable waters, 100-year flood elevations and delineated wetland boundaries, if any. If not available, appropriate flood zone determination or wetland delineation, or both, may be required at the applicant's expense.
 4. Map of infiltration rates, depth to bedrock, and depth to seasonal high water table.
 5. Steep slopes where areas of 33% or more.
 6. Bluff areas meeting the current definition of the MnDNR.
 7. Wooded area and tree survey as defined by the zoning authority.
 8. Agricultural Land preservation area(s), County Biological Survey sites, or other officially designated natural resources.
 9. Hydrologic calculations for volume runoff, velocities, and peak flow rates by watershed, for the 2-yr, 10-yr, and 100-yr 24-hour storm events. These shall include: pre-existing peak flow rates, assumed runoff curve numbers, time of concentration used in calculations, and the 100-year flood elevation with and without the floodway if a flood insurance study has been done by the National Flood Insurance Program.
- Bankfull discharge rate (1.5 year recurrence interval) of creek or stream if there is a waterway on the site or if the site discharges directly to the waterway.
- Proposed Conditions - A complete site plan and specifications, signed by the person who designed the plan shall be drawn to scale appropriate to the site of the project and suitable for the review to be performed, shall be clearly labeled with a north arrow and a date of preparation, and shall include, at a minimum, the following information:
 1. Project map – A map indicating site boundaries and areas not to be disturbed.
 2. Property lines and lot dimensions of plat.
 3. The dimensions and setbacks of all buildings and easements.
 4. Identify all drain tiles that would affect the project site and within one (1) mile of project boundary, including. Show ordinary high water marks of all navigable waters, 100-year flood elevations and delineated wetland boundaries, if any. If not available, appropriate flood zone determination or wetland delineation, or both, may be required at the applicant's expense.
 5. Location and engineered designs for structural stormwater management practices including stormwater treatment devices that remove oil and floatable material (e.g., basin outlets with submerged entrances).
 6. Normal water level, high water level, and emergency overflow elevations for the site.
 7. Floodway and flood fringe boundary, if available.
 8. Any other information pertinent to the particular project that, in the opinion of the City, is necessary for the review of the project.
- All proposed stormwater practices, hydrologic models, and design methodologies shall be reviewed by the City and certified for compliance by the City in accordance with their plans and specifications.
- A pre-construction meeting, preferably at the construction site, including the operator/general contractor, the site grading contractor, the City of Alexandria Stormwater Inspector.



ALEXANDRIA CONSTRUCTION STORMWATER PERMIT (CSP)

City of Alexandria
704 Broadway
Alexandria, MN 56308
(320) 763-6678 Telephone
(320) 763-3511 Fax

CSP Permit Number:
Other Permit Number:
Date Issued:

Site Information

Project Address: Owners Name:

Project Name: Project Type: Acres to be Disturbed:

Natural Resource Feature within 100 feet: Yes No Storm Drain within 100 feet: Yes No

If Yes, Identify Natural Resource Feature(s):

Proposed Start Date: Proposed Completion Date:

Scope of Land Disturbance Activity:

- Category 1 Land Disturbance
Category 2 Land Disturbance
Category 3 Land Disturbance*
*Separate MPCA Construction Stormwater Permit Required
Part of Common Development Plan
Site within 1 mile of Lake Winona

Best Management Practices

Areas not being actively worked to be stabilized within 14 days.
**(Areas within 1 mile of Lake Winona 7 days)
Install/maintain perimeter controls and sediment barriers.
Keep discharge points and receiving waters free of sediment.
Protect natural resources (streams, wetlands, mature trees, etc).
Properly protect storm drain inlets.
Keep sediment from tracking onto street.
Keep trash/litter collected and contained.
Keep concrete washout areas clearly marked and maintained.
Keep fueling, cleaning, maintenance areas free of leaks and spills.
Keep potential stormwater contaminants inside or under cover.
Make sure previously disturbed areas are/remain stabilized.
Properly located and stabilize all stockpiles.
Check site for compliance after each 1/2-inch (+) rain event.

Party Responsible for Installing, Implementing and Maintaining Erosion and Sediment Control per Plan

Name:

- Operator/General Contractor
Owner (if Owner is Operator/General Contractor)

Contact Person:

Address:

City: State: Zip:

Telephone: Cell:

Email:

GENERAL NOTES TO PERMITEE:

The costs associated with an on-site review by the City Engineer of reported stormwater management violations will be the responsibility of the property owner. Re-inspections of Non-Compliant Erosion and Sediment Control BMPs will be subject to re-inspection fees and may result in a "stop work" order being issued to the site. Any permit issued becomes invalid if the work authorized by the permit is suspended or abandoned for more than 180 days. The 180 days commences the first day the work was suspended or abandoned.

CERTIFICATION STATEMENT

I certify under penalty of law that this document and all attachments, to the best of my knowledge and belief, true, accurate and complete. I am aware that there are significant penalties for submitting false information, including the possibility of fine and imprisonment for knowing violations.

Print Name and Title:

Signature of Permit Holder: Date:

Approved By: Date: